

Technical Data

Pump Name

BHSE 635-5-R3 5/05.2 M6P

Customer	Date	2024-06-13	Company
Contact	Item no.		Issued by
Phone	Project		Phone
E-mail	Project ID	Proiect redenumit 2024-06-13 09:28:44	E-mail

Requested data

1	Pump type		SUBMERSIBLE MULTISTAGE PUMPS	Fluid		Water
2	Number of pumps / Reserve		1 / 0	Liquid temperature	°C	20
3	Flow	m³/h		Kin. viscosity	mm²/s	1.005
4	Head	m		Vapour pressure	bar	0.0234
5	Geodetic head	m		PH value		
6	Inlet pressure (pin)	bar	0	Density	kg/m³	998.3
7	Available system NPSH			Solids	Weight %	0
8	Ambient temperature	°C	20			

Pump

9	Pump Name		BHSE 635-5-R3 5/05.2 M6P	Frequency	Hz	50	
10	Design		SUBMERSIBLE MULTISTAGE PUMPS	Installation type		STANDARD	
11	Manufacturer		EBARA	Impeller Diameter	Max.	mm	92
12	Speed	rpm	2900		Designed	mm	92
13	No. of Stage		5		Min.	mm	92
14	Connection	Suction side		Flow	Operating	m³/h	
15	Connection	Discharge side			Max-	m³/h	35
16	Max Working Pressure	bar			Min-	m³/h	15
17	Shut-off head	bar	6.07	Head	Operating	m	
18	Total weight	kg	See the table of "Dimensions".		- (Qmax.)	m	37.9
19	Shaft power	kW			- (Qmin.)	m	55.2
20				Max. Shaft Power at max. impeller	kW	5.16	
21	Required pump NPSH	m		Efficiency	%		

Materials

22	Casing		Casting iron	Washers		Stainless steel
23	Impeller		Stainless steel - precision casting	Paint (Motor)		Synthetic alkyd
24	Shaft		Stainless steel			
25	Stainet		Stainless steel			
26	Screw		Stainless steel			
27	Nuts		Stainless steel			

Motor

28	Manufacturer		EBAS	Insulation class		Y
29	Type		M6P 7HP 220V TRIF. 50Hz	Phases		3~
30	Specific design		Submersible water filled type / 50 Hz / Pole pairs 1	Frame size		6
31	Rated power	kW	5.22	Weight	kg	46
32	Number of poles		2	Electric voltage	V	220
33	Speed	rpm	2854	Electric current	A	22.5
34	Degree of protection		IP 68			
35						

Remarks

Performance Curve

Pump Name

BHSE 635-5-R3 5/05.2 M6P

Customer	Date	2024-06-13	Company
Contact	Item no.		Issued by
Phone	Project		Phone
E-mail	Project ID	Project redenumit 2024-06-13 09:28:44	E-mail

Requested data

1	Flow	m³/h	
2	Head	m	
3	Geodetic head	m	

Pump

Operating flow	m³/h		Frequency	Hz	50
Operating head	m		Number of poles		2
Impeller diameter designed	mm	92	Speed	rpm	2900

Test standard: ISO 9906:2012 - Grade3B

Water; 20°C; 998.3kg/m³; 1mm²/s

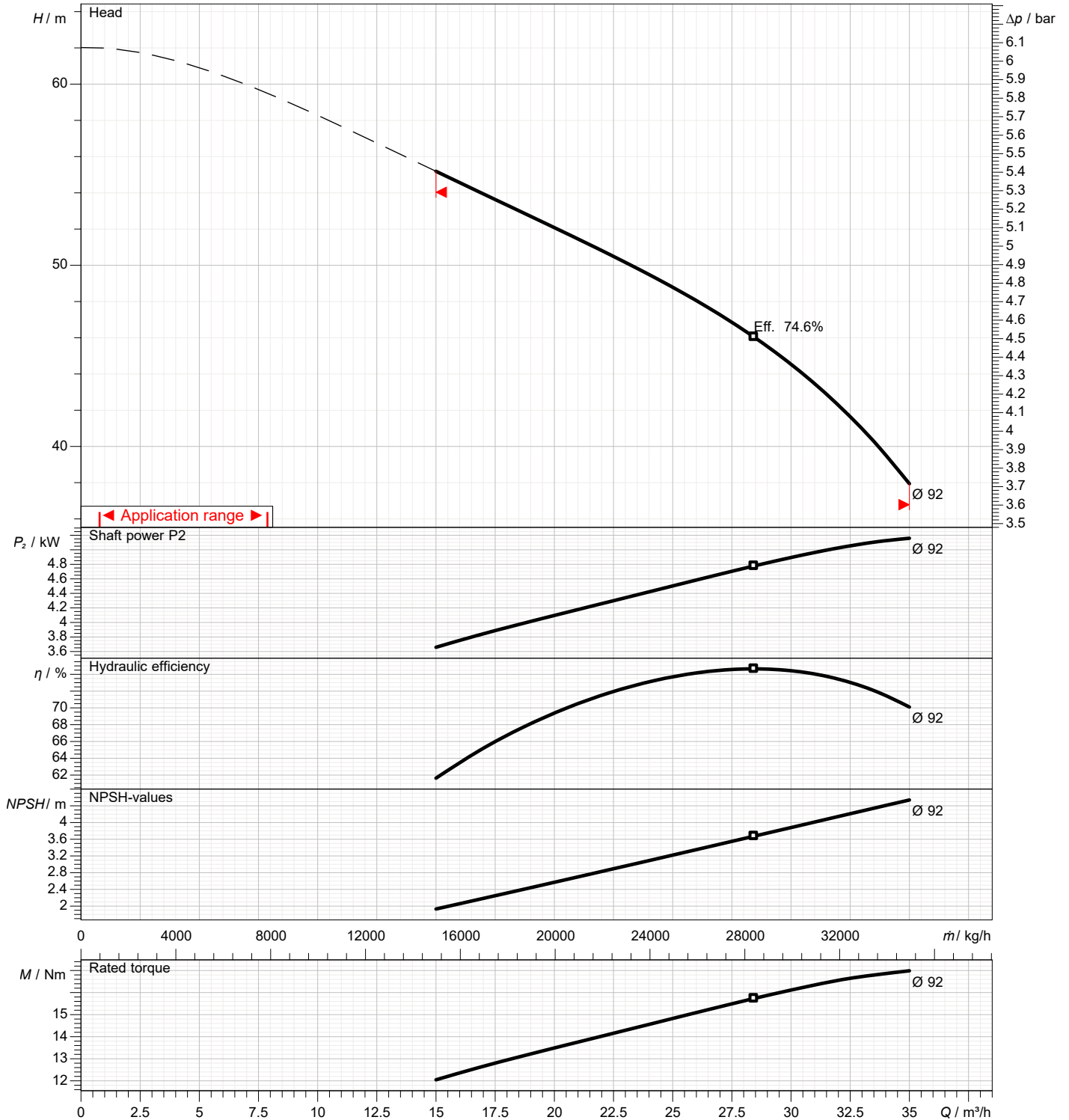

Dimensions

Pump name BHSE 635-5-R3 5/05.2 M6P

Customer	Date 2024-06-13	Company
Contact	Item no.	Issued by
Phone	Project	Phone
E-mail	Project ID Proiect redenumit 2024-06-13 09:28:44	E-mail



Dimensions in		mm						
1	D_01 Cable	144						
2	D_02 Cable	146						
3	L	1529						
4	LB	919						
5	LM	610						
6	M Weight (kg)	46						
7	P Weight (kg)	33.5						
8	Total Weight (kg)	79.5						
9	Φ (inch)	3						
10								
11								
12								
13								
14								
15								

(1/4) Construction

Pump name

Customer	Date 2024-06-13	Company
Contact	Item no.	Issued by
Phone	Project	Phone
E-mail	Project ID Proiect redenumit 2024-06-13 09:28:44	E-mail



(2/4)

Construction

Pump name

Customer	Date	2024-06-13	Company
Contact	Item no.		Issued by
Phone	Project		Phone
E-mail	Project ID	Project redenumit 2024-06-13 09:28:44	E-mail

BHSE6_Parts Table		
No.	Name	MATERIAL
1	DISCHARGE CASING	CAST IRON
2	SPRING	STAINLESS STEEL
3	VALVE DISK	CAST IRON
4	VALVE SHEET	NBR RUBBER
5	BEARING SLEEVE	NBR RUBBER
6	SPRING WASHER	STAINLESS STEEL
7	BOLT	STAINLESS STEEL
8	INTERMEDIATE CASING 2	CAST IRON
9	TAPER COLLET	STAINLESS STEEL
10	SHEET PACKING	PAPER
11	CASING WEARING RING	NBR / 304
12	INTERMEDIATE CASING	CAST IRON
13	IMPELLER	STAINLESS STEEL
14	SHAFT	STAINLESS STEEL
15	BOLT	STAINLESS STEEL
16	CABLE COVER	STAINLESS STEEL
17	KEY	STAINLESS STEEL
18	STRAINER	STAINLESS STEEL
19	COUPLING	STAINLESS STEEL
20	BOLT	CARBON STEEL
21	BOLT	STAINLESS STEEL
22	WASHER	STAINLESS STEEL
23	SUCTION CASING	CAST IRON
24	ADAPTER	CAST IRON
25	LOCKING SUPPORT	CARBON STEEL/STAINLESS STEEL

(3/4)

Construction

Pump name

Customer	Date 2024-06-13	Company
Contact	Item no.	Issued by
Phone	Project	Phone
E-mail	Project ID Proiect redenumit 2024-06-13 09:28:44	E-mail

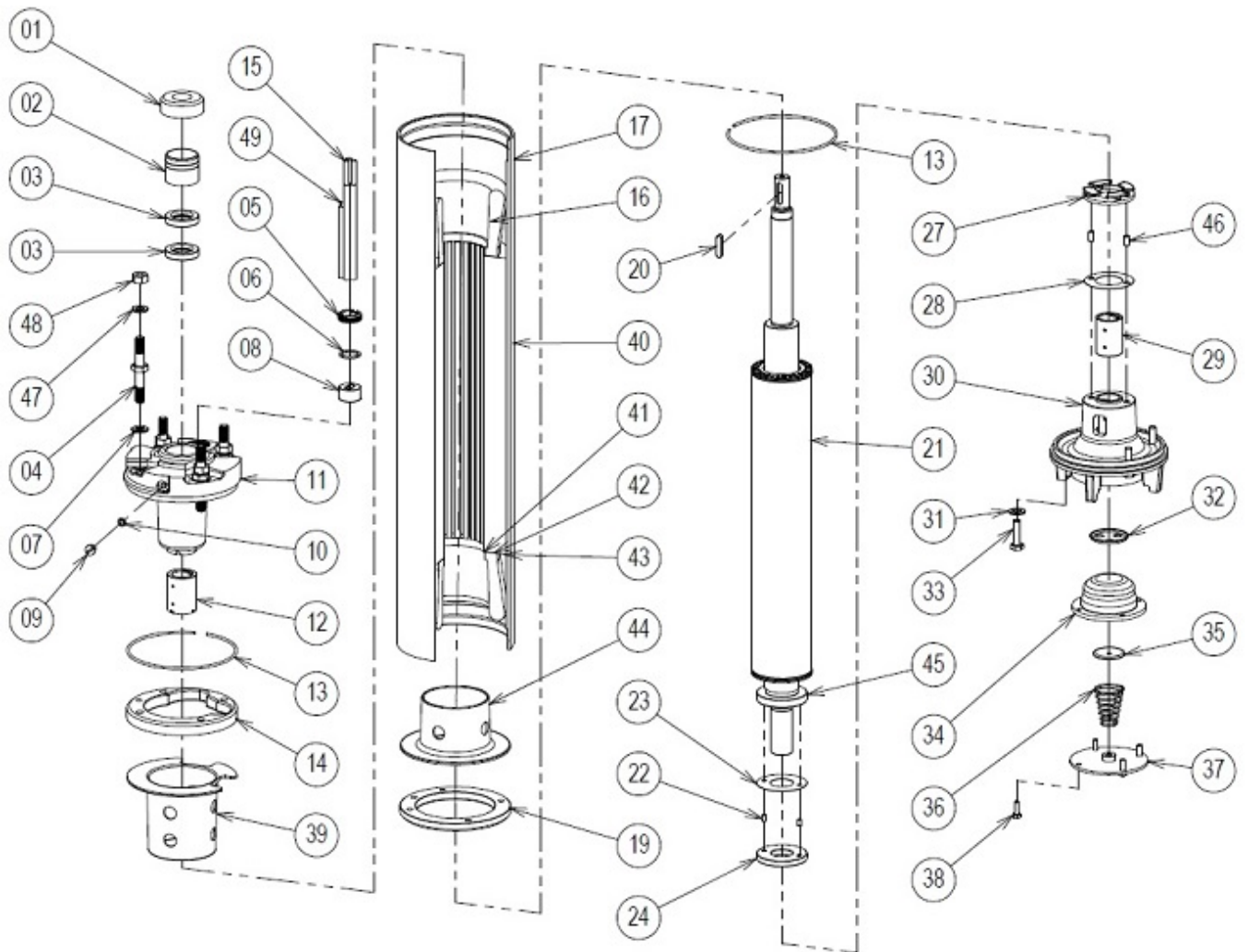

(4/4)

Construction

Pump name

Customer	Date 2024-06-13	Company
Contact	Item no.	Issued by
Phone	Project	Phone
E-mail	Project ID Project redenumit 2024-06-13 09:28:44	E-mail

Motor M6P_Parts Table		
No.	Name	MATERIAL
1	SAND SLINGER	CARBON STEEL/NBR
2	SEAL COVER	CARBON STEEL
3	OIL SEAL	NBR
4	CABLE NUT	STAINLESS STEEL
5	STUD BOLT	STAINLESS STEEL
6	PRESSURE RING FOR CABLE	BRASS
7	CABLE GLAND	NBR
8	METAL GASKET	BRASS
9	PLUG	BRASS
10	O-RING	NBR
11	UPPER BRACKET	CAST IRON
12	BEARING	GRAPHITE
13	STOP RING	CARBON STEEL
14	UPPER FRAME RING	CARBON STEEL
15	LEAD CABLE	CUPPER
16	COIL	CUPPER
17	MOTOR FRAME	CARBON STEEL
18	COIL PROTECTOR	PVC
19	LOWER FRAME RING	CARBON STEEL
20	KEY	STAINLESS STEEL
21	ROTOR WITH SHAFT	STAINLESS STEEL/CARBON STEEL
22	KEY	STAINLESS STEEL
24	LOWER BRACKET	CAST IRON
25	UPPER BEARING "A"	GRAPHITE
26	UPPER BEARING "B"	GRAPHITE
27	STUD BOLT	STAINLESS STEEL
28	LOCKING PIN	STAINLESS STEEL
29	THRUST DISK	STAINLESS STEEL
30	NUT CAP	CARBON STEEL
32	STOP RING	CARBON STEEL
33	THRUST PAD	STAINLESS STEEL
34	O-RING	NBR
35	OSCILLATING DISC	CAST IRON
36	THRUST BEARING HOUSING	CAST IRON
37	ADJUSTING NUT	CARBON STEEL
38	NUT	CARBON STEEL
39	DIAPHRAGM PROTECTOR	STAINLESS STEEL
40	PLUG	BRASS
41	DIAPHRAGM	CR
42	SPRING DISC	STAINLESS STEEL
43	SPRING	STAINLESS STEEL
44	DIAPHRAGM COVER	STAINLESS STEEL
45	BOLT	CARBON STEEL
46	COMPLETE STATOR	-
47	SLOT ISOLATOR	POLYESTER
48	WEDGE ISOLATOR	POLYESTER
50	SPRING WASHER	STAINLESS STEEL
51	NUT	STAINLESS STEEL