

Technical Data

Pump Name

BHSE 8160-10 6/149.2 M10

Customer	Date	2024-07-01	Company
Contact	Item no.		Issued by
Phone	Project		Phone
E-mail	Project ID	Proiect redenumit 2024-07-01 15:55:48	E-mail

Requested data

1	Pump type		SUBMERSIBLE MULTISTAGE PUMPS	Fluid		Water
2	Number of pumps / Reserve		1 / 0	Liquid temperature	°C	20
3	Flow	m³/h		Kin. viscosity	mm²/s	1.005
4	Head	m		Vapour pressure	bar	0.0234
5	Geodetic head	m		PH value		
6	Inlet pressure (pin)	bar	0	Density	kg/m³	998.3
7	Available system NPSH			Solids	Weight %	0
8	Ambient temperature	°C	20			

Pump

9	Pump Name		BHSE 8160-10 6/149.2 M10	Frequency	Hz	60	
10	Design		SUBMERSIBLE MULTISTAGE PUMPS	Installation type		STANDARD	
11	Manufacturer		EBARA	Impeller Diameter	Max.	mm	137
12	Speed	rpm	3500		Designed	mm	137
13	No. of Stage		10		Min.	mm	137
14	Connection	Suction side		Flow	Operating	m³/h	
15	Connection	Discharge side			Max-	m³/h	185
16	Max Working Pressure	bar			Min-	m³/h	100
17	Shut-off head	bar	36.20	Head	Operating	m	
18	Total weight	kg	See the table of "Dimensions".		- (Qmax.)	m	240.3
19	Shaft power	kW			- (Qmin.)	m	329.3
20				Max. Shaft Power at max. impeller	kW	149.53	
21	Required pump NPSH	m		Efficiency	%		

Materials

22	Casing		Casting iron	Washers		Stainless steel
23	Impeller		Stainless steel - precision casting	Paint (Motor)		Synthetic alkyd
24	Shaft		Stainless steel			
25	Stainet		Stainless steel			
26	Screw		Stainless steel			
27	Nuts		Stainless steel			

Motor

28	Manufacturer		EBAS	Insulation class		Y
29	Type		M10 200HP 380V TRIF. 60Hz	Phases		3~
30	Specific design		Submersible water filled type / 60 Hz / Pole pairs 1	Frame size		10
31	Rated power	kW	149.2	Weight	kg	380
32	Number of poles		2	Electric voltage	V	380
33	Speed	rpm	3450	Electric current	A	333
34	Degree of protection		IP 68			
35						

Remarks

Performance Curve

Pump Name

BHSE 8160-10 6/149.2 M10

Customer	Date	2024-07-01	Company
Contact	Item no.		Issued by
Phone	Project		Phone
E-mail	Project ID	Project redenumit 2024-07-01 15:55:48	E-mail

Requested data

1	Flow	m³/h	
2	Head	m	
3	Geodetic head	m	

Pump

Operating flow	m³/h		Frequency	Hz	60
Operating head	m		Number of poles		2
Impeller diameter designed	mm	137	Speed	rpm	3500

Test standard: ISO 9906:2012 - Grade3B

Water; 20°C; 998.3kg/m³; 1mm²/s

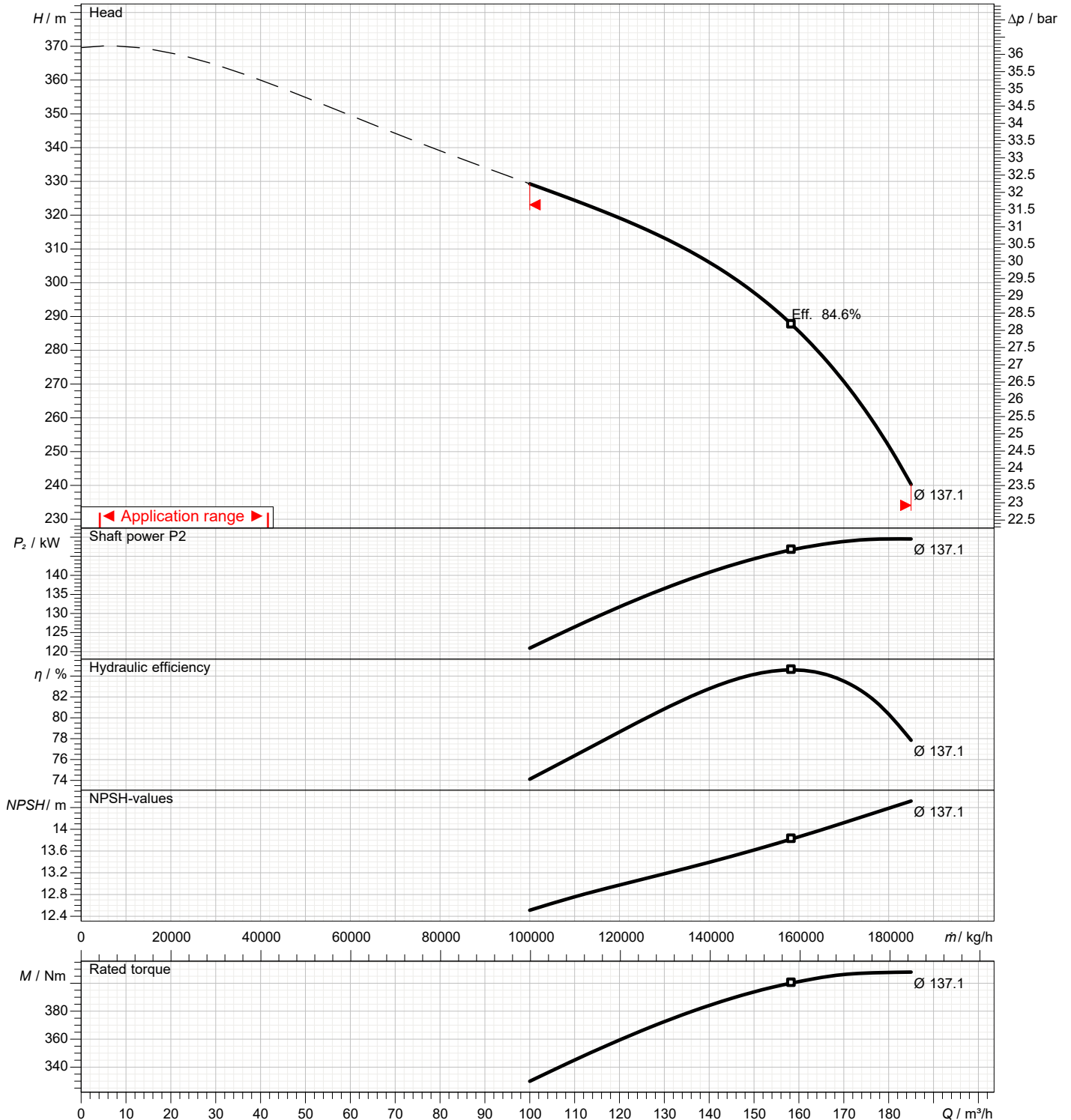

Dimensions

Pump name BHSE 8160-10 6/149.2 M10

Customer	Date 2024-07-01	Company
Contact	Item no.	Issued by
Phone	Project	Phone
E-mail	Project ID Proiect redenumit 2024-07-01 15:55:48	E-mail



Dimensions in		mm						
1	L	4232						
2	LB	2368						
3	LM	1864						
4	M Weight (kg)	380						
5	P Weight (kg)	179.1						
6	Total Weight (kg)	559.1						
7	Φ (inch)	5 (inch)						
8								
9								
10								
11								
12								
13								
14								
15								

(1/4) Construction

Pump name

Customer	Date 2024-07-01	Company
Contact	Item no.	Issued by
Phone	Project	Phone
E-mail	Project ID Proiect redenumit 2024-07-01 15:55:48	E-mail

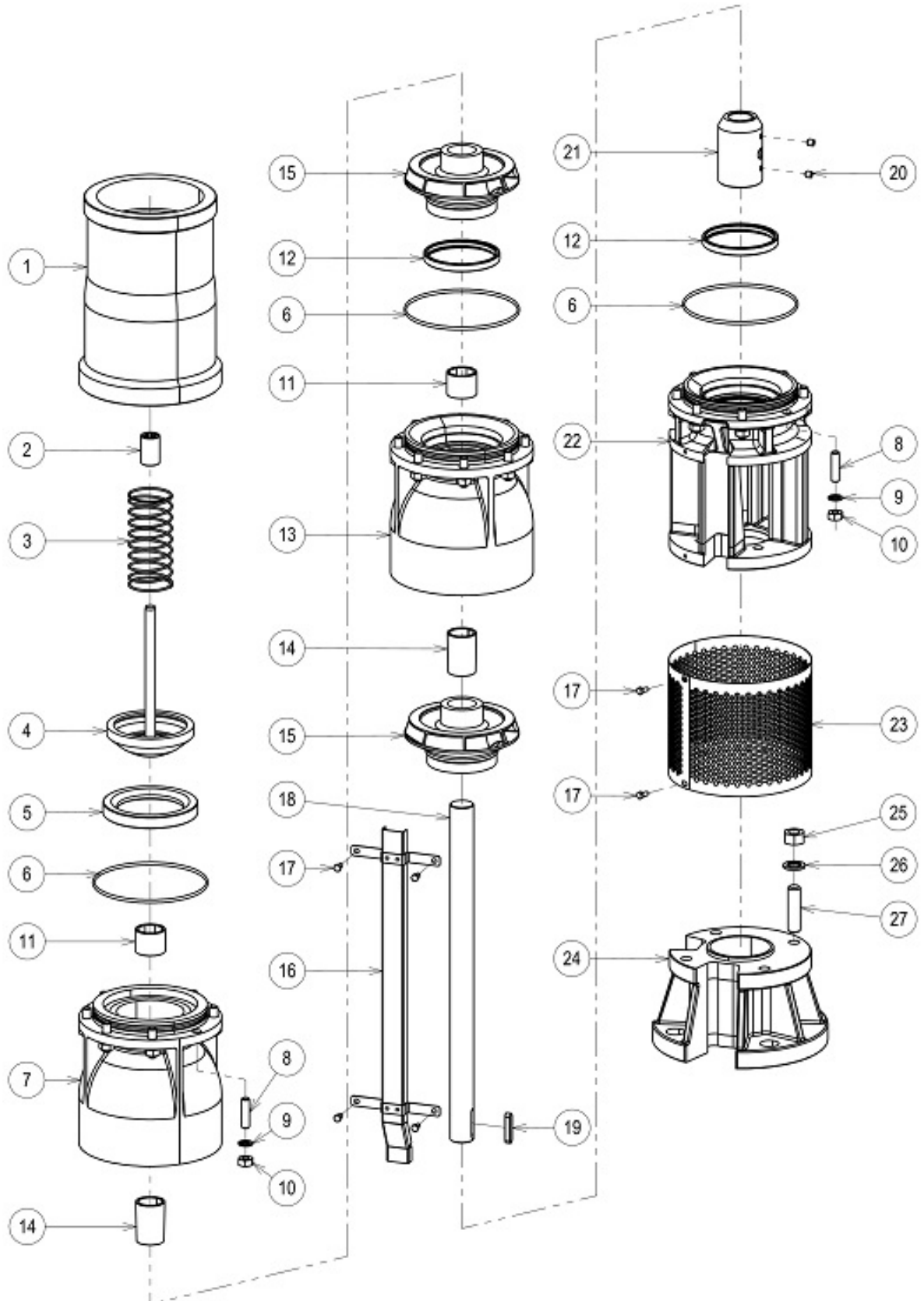

(2/4)

Construction

Pump name

Customer	Date	2024-07-01	Company
Contact	Item no.		Issued by
Phone	Project		Phone
E-mail	Project ID	Project redenumit 2024-07-01 15:55:48	E-mail

BHSE8_Parts Table		
No.	Name	MATERIAL
1	DISCHARGE CASING	CAST IRON
2	VALVE ROD GUIDE	BRASS
3	SPRING	STAINLESS STEEL
4	VALVE DISK	STAINLESS STEEL
5	VALVE SHEET	NBR RUBBER
6	O-RING	NBR
7	INTERMEDIATE CASING 2	CAST IRON
8	STUD BOLT	STAINLESS STEEL
9	SPRING WASHER	STAINLESS STEEL
10	NUT	STAINLESS STEEL
11	BEARING SLEEVE	NBR
12	CASING WEARING RING	BRASS
13	INTERMEDIATE CASING	CAST IRON
14	TAPER COLLET	STAINLESS STEEL
15	IMPELLER	STAINLESS STEEL
16	CABLE COVER	STAINLESS STEEL
17	BOLT	STAINLESS STEEL
18	SHAFT	STAINLESS STEEL
19	KEY	STAINLESS STEEL
20	BOLT	CARBON STEEL
21	COUPLING	STAINLESS STEEL
22	SUCTION CASING	CAST IRON
23	STRAINER	STAINLESS STEEL
24	ADAPTER	CAST IRON
25	NUT	STAINLESS STEEL
26	SPRING WASHER	STAINLESS STEEL
27	STUD BOLT	STAINLESS STEEL

(3/4)

Construction

Pump name

Customer	Date 2024-07-01	Company
Contact	Item no.	Issued by
Phone	Project	Phone
E-mail	Project ID Proiect redenumit 2024-07-01 15:55:48	E-mail



(4/4) Construction

Pump name

Customer	Date 2024-07-01	Company
Contact	Item no.	Issued by
Phone	Project	Phone
E-mail	Project ID Project redenumit 2024-07-01 15:55:48	E-mail

Motor M10_Parts Table		
No.	Name	MATERIAL
1	SAND SLINGER	CARBON STEEL/NBR
2	SEAL COVER	CARBON STEEL
3	OIL SEAL	NBR
4	ESPACIADOR	BRASS
5	CABLE NUT	STAINLESS STEEL
7	PRESSURE RING FOR CABLE	BRASS
8	CABLE GLAND "A"	NBR
9	CABLE GLAND "B"	NBR
10	PRESSURE RING FOR CABLE	BRASS
11	STUD BOLT	STAINLESS STEEL
12	BOLT	CARBON STEEL
13	METAL GASKET	BRASS
14	PLUG	BRASS
15	UPPER BRACKET	CAST IRON
17	UPPER BEARING	GRAPHITE
18	STOP RING	CARBON STEEL
19	UPPER FRAME RING	CARBON STEEL
20	COIL PROTECTOR RING	STAINLESS STEEL
21	LEAD CABLE	CUPPER
22	COIL	CUPPER
23	MOTOR FRAME	CARBON STEEL
24	COIL PROTECTOR	NBR
25	LOWER FRAME RING	CARBON STEEL
26	KEY	STAINLESS STEEL
27	ROTOR WITH SHAFT	STAINLESS STEEL/CARBON STEEL
28	KEY	STAINLESS STEEL
29	DISTANCING RING FOR SUPP	BRASS
30	LOWER BRACKET	CAST IRON
31	SPRING WASHER	STAINLESS STEEL
32	BOLT	CARBON STEEL
33	UPPER BEARING "A"	GRAPHITE
34	THRUST DISK	STAINLESS STEEL
37	STOP RING	CARBON STEEL
38	THRUST PAD	STAINLESS STEEL
39	O-RING	NBR
40	OSCILLATING DISC	CAST IRON
41	THRUST BEARING HOUSING	CAST IRON
43	BOLT	CARBON STEEL
44	ADJUSTING NUT	CARBON STEEL
45	NUT	STAINLESS STEEL
46	DIAPHRAGM PROTECTOR	STAINLESS STEEL
47	PLUG	BRASS
48	DIAPHRAGM	CR
49	SPRING DISC	STAINLESS STEEL
50	SPRING	STAINLESS STEEL
51	DIAPHRAGM COVER	STAINLESS STEEL
52	BOLT	CARBON STEEL
53	COMPLETE STATOR	-
54	INTERMEDIATE WEDGE	PTFE
55	SLOT ISOLATOR	POLYESTER
56	WEDGE ISOLATOR	POLYESTER
57	WEDGE	PLASTIC
58	SPRING WASHER	STAINLESS STEEL
59	NUT	STAINLESS STEEL
60	O-RING	NBR