

Technical Data

Pump Name

HVM 5-5N/1.5M

Customer	Date	2024-06-16	Company
Contact	Item no.		Issued by
Phone	Project		Phone
E-mail	Project ID	Proiect redenumit 2024-06-16 15:45:44	E-mail

Requested data

1	Pump type	MULTISTAGE CENRIFUGAL PUMPS	Fluid	Water
2	Number of pumps / Reserve	1 / 0	Liquid temperature	°C
3	Flow	m³/h	Kin. viscosity	mm²/s
4	Head	m	Vapour pressure	bar
5	Geodetic head	m	PH value	
6	Inlet pressure (pin)	bar	Density	kg/m³
7	Available system NPSH		Solids	Weight %
8	Ambient temperature	°C		

Pump

9	Pump Name	HVM 5-5N/1.5M	Frequency	Hz	50	
10	Design	MULTISTAGE CENRIFUGAL PUMPS	Installation type		STANDARD	
11	Manufacturer	EBARA	Impeller Diameter	Max.	mm	
12	Speed	rpm		2850	Designed	mm
13	No. of Stage	5		Min.	mm	97
14	Connection	Suction side	ISO 228	Flow	Operating	m³/h
15	Connection	Discharge side	ISO 228		Max-	m³/h
16	Max Working Pressure	bar			Min-	m³/h
17	Shut-off head	bar	5.64	Head	Operating	m
18	Total weight	kg	See the table of "Dimensions".		- (Qmax.)	m
19	Shaft power	kW			- (Qmin.)	m
20				Max. Shaft Power at max. impeller	kW	1.09
21	Required pump NPSH	m		Efficiency	%	

Materials

22				
23				
24				
25				
26				
27				

Motor

28	Manufacturer	EPE Standard	Insulation class		
29	Type	TEFC_HVM 5-5N/1.5M_230_Single Phase	Phases	1~	
30	Specific design	- / 50 Hz / Pole pairs 1	Frame size		
31	Rated power	kW	1.5	Weight	kg
32	Number of poles	2	Electric voltage	V	230
33	Speed	rpm	2850	Electric current	A
34	Degree of protection	IP55			
35					

Remarks

Performance Curve

Pump Name

HVM 5-5N/1.5M

Customer	Date	2024-06-16	Company
Contact	Item no.		Issued by
Phone	Project		Phone
E-mail	Project ID	Proiect redenumit 2024-06-16 15:45:44	E-mail

Requested data

1	Flow	m³/h	
2	Head	m	
3	Geodetic head	m	

Pump

Operating flow	m³/h		Frequency	Hz	50
Operating head	m		Number of poles		2
Impeller diameter designed	mm	97	Speed	rpm	2850

Test standard: ISO 9906:2012 - Grade3B

Water; 20°C; 998.3kg/m³; 1mm²/s

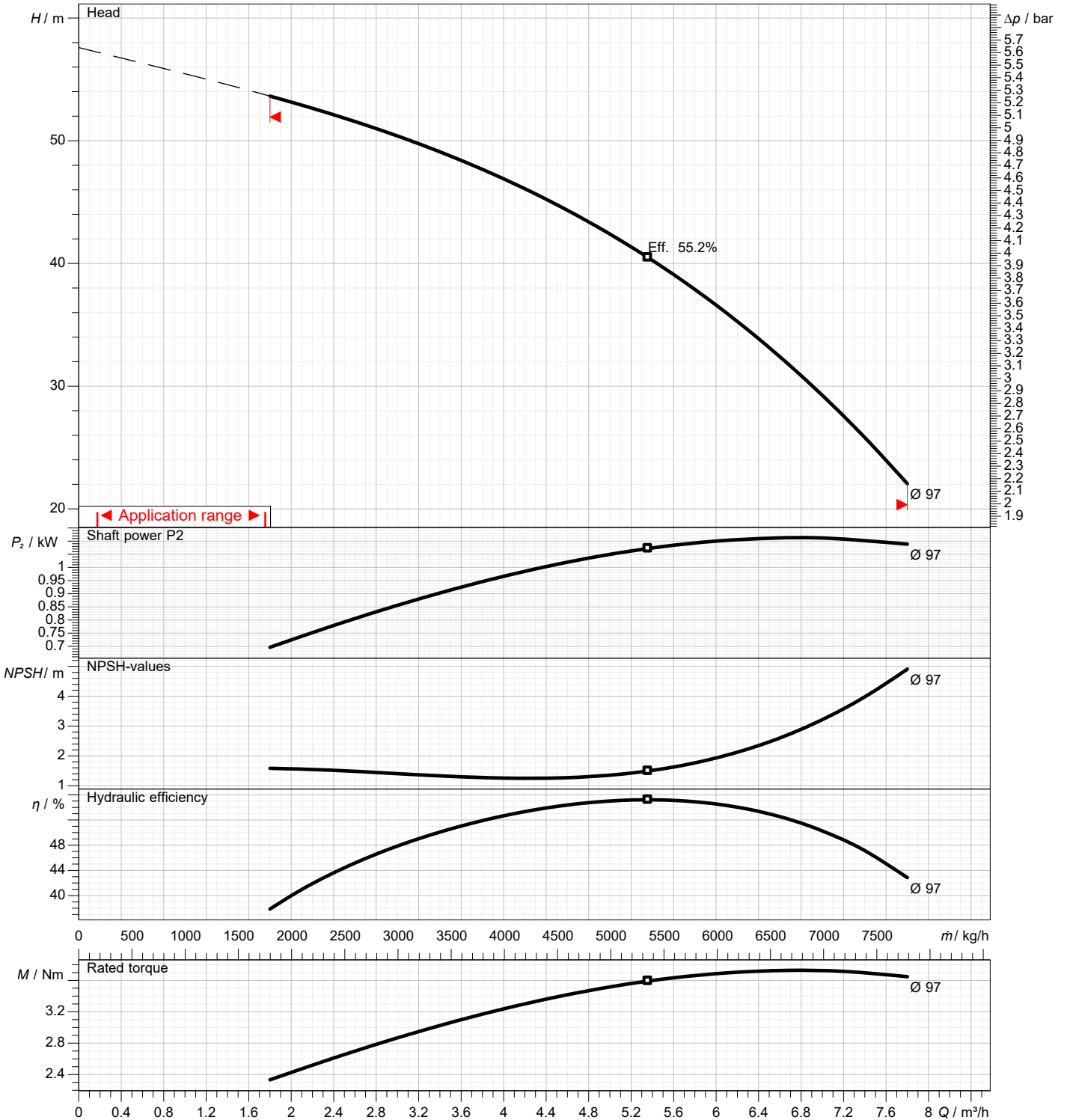

Dimensions

Pump name HVM 5-5N/1.5M

Customer	Date 2024-06-16	Company
Contact	Item no.	Issued by
Phone	Project	Phone
E-mail	Project ID Proiect redenumit 2024-06-16 15:45:44	E-mail

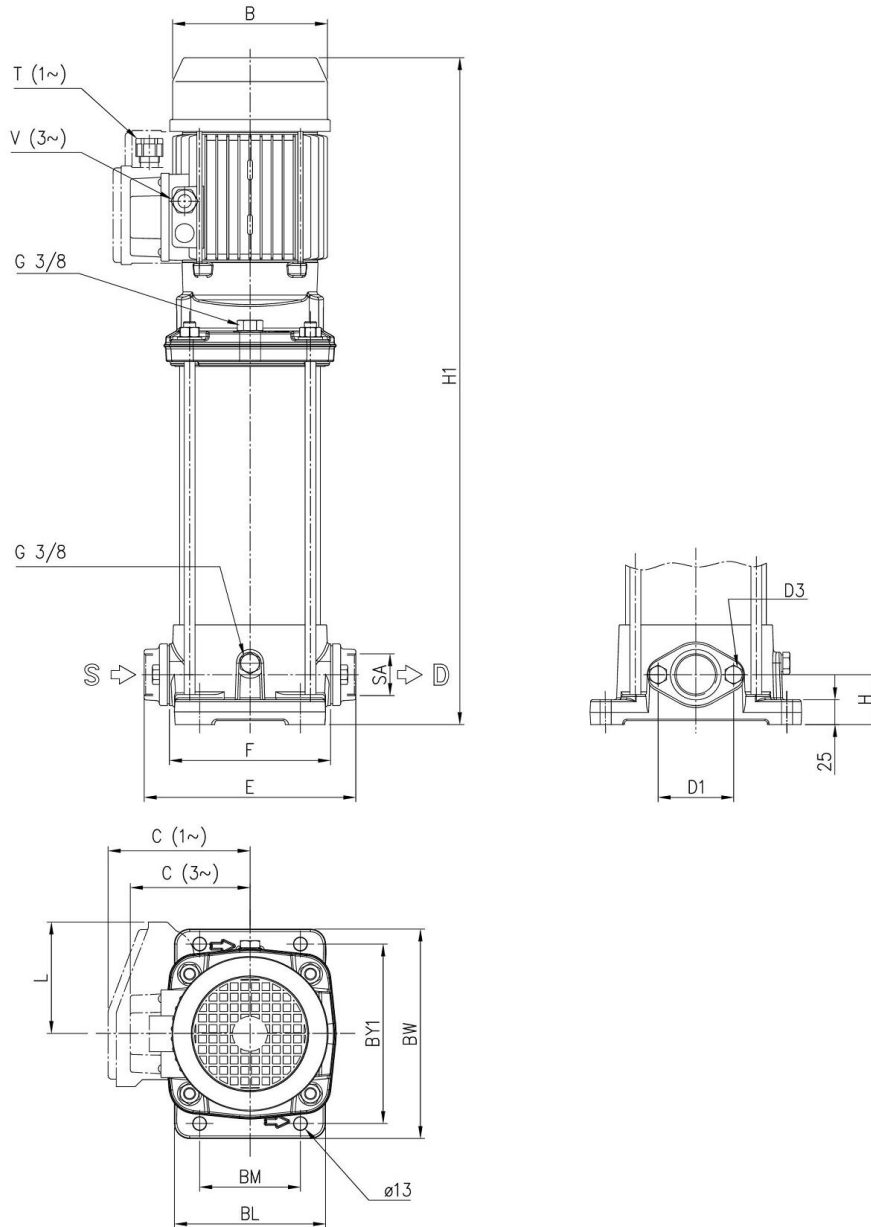

Dimensions in		mm					
1	B	155	Weight kg	24.1			
2	BL	150					
3	BM	100					
4	BW	210					
5	BY1	180					
6	C	136					
7	D1	75					
8	D3	M10					
9	E	209					
10	F	160					
11	H	50					
12	H1	549					
13	L	112					
14	SA	G1 1/4					
15	T	M20x1.5					

(1/3)

Construction

Pump name

Customer	Date 2024-06-16	Company
Contact	Item no.	Issued by
Phone	Project	Phone
E-mail	Project ID Proiect redenumit 2024-06-16 15:45:44	E-mail

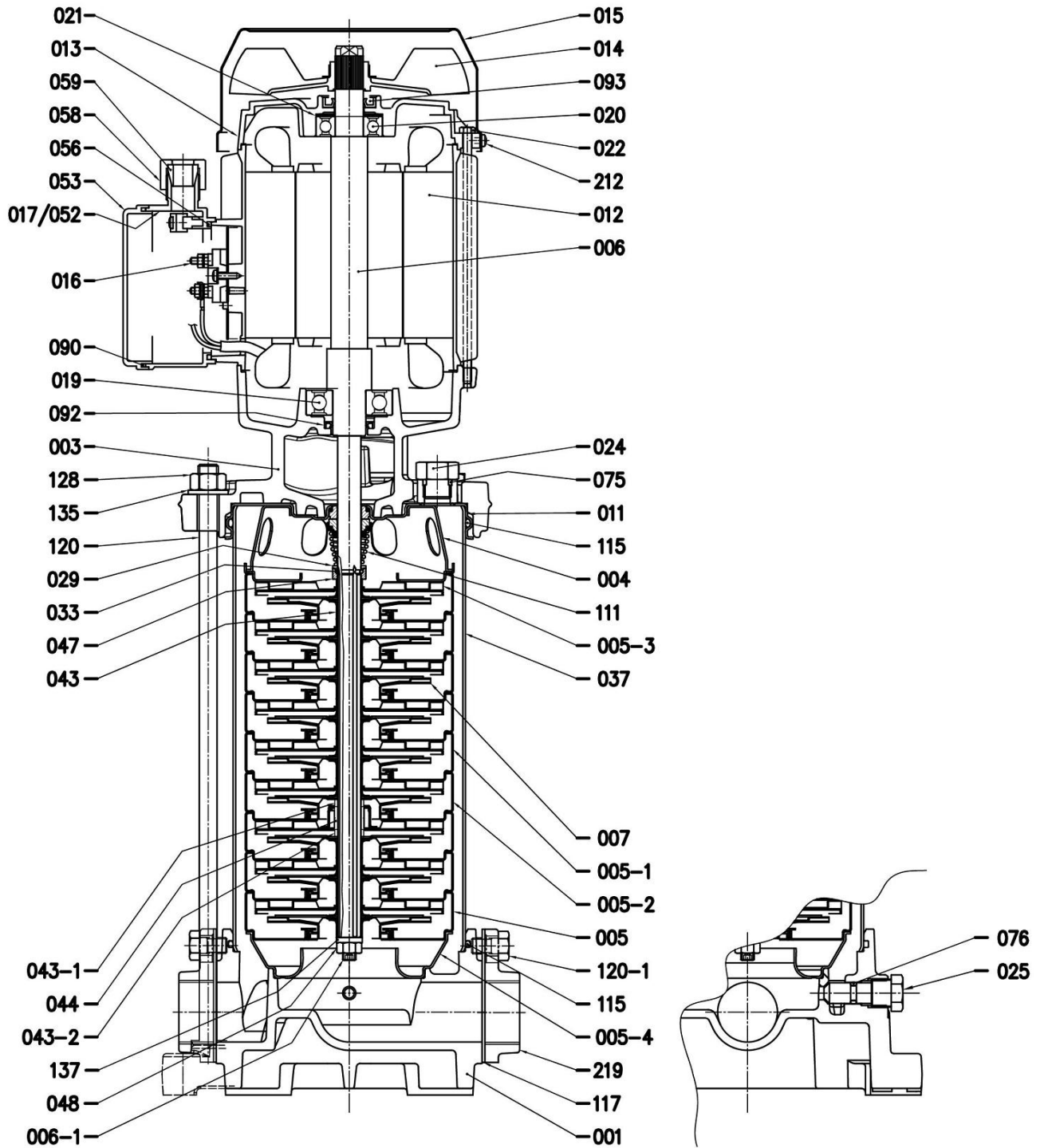

(2/3)

Construction

Pump name

Customer	Date	2024-06-16	Company
Contact	Item no.		Issued by
Phone	Project		Phone
E-mail	Project ID	Proiect redenumit 2024-06-16 15:45:44	E-mail

N°	PART NAME	MATERIAL	DIMENSION	STANDARD	Q.TY
001	Casing	Cast Iron EN-GJL 250 EN1561			1
003	Bracket	Cast Iron EN-GJL 250 EN1561			1
004	Discharge cover	EN 1.4301 (AISI 304)			1
005	Intermediate casing (suction)	EN 1.4301 (AISI 304)+PTFE			1
005-1	Intermediate casing	EN 1.4301 (AISI 304)+PTFE			[1]
005-2	Intermediate casing (bearing)	EN 1.4301 (AISI 304)+PTFE+Ceramic			[1]
005-3	Discharge casing	EN 1.4301 (AISI 304)+PTFE			1
005-4	Suction baffle	EN 1.4301 (AISI 304)			1
006	Shaft with rotor	-			1
006-1	Pump Shaft	EN 1.4301 (AISI 304)			1
007	Impeller	EN 1.4301 (AISI 304)			[1]
011	Casing cover	EN 1.4301 (AISI 304)			1
012	Motor frame with stator	-			1
013	Motor cover	Aluminium			1
014	Fan	PA			1
015	Fan cover	Fe P04 Galvanized			1
016	Terminal board	-			1
017	Terminal box cover	Aluminium			[1]
019	Bearing	-			1
020	Bearing	-			1
021	Adjusting ring	Steel C70			1
022	Tie rod	Fe 42 Galvanized			4
024	Plug	EN 1.4301 (AISI 304)			1
025	Plug	EN 1.4301 (AISI 304)			1
029	Washer for mechanical seal	EN 1.4301 (AISI 304)			1
033	Ring	EN 1.4301 (AISI 304)			2
037	Outer casing	EN 1.4301 (AISI 304)			1
043	Impeller spacer	EN 1.4301 (AISI 304)			[1]
043-1	Shaft sleeve (adjustment) [1]	EN 1.4301 (AISI 304)			[1]
043-2	Shaft sleeve (adjustment) [1]	EN 1.4301 (AISI 304)			[1]
044	Shaft sleeve (bearing)	EN 1.4460 (AISI 329)			[1]
047	Ring holder	EN 1.4301 (AISI 304)			1
048	Nut	EN 1.4301 (AISI 304)	M8	UNI 5588	1
052	Capacitor box [2]	ABS			[1]
053	Capacitor box cover [2]	ABS			[1]
056	Box gasket	NBR			1
058	Ring nut	-			[1]
059	Conic gasket	NBR			[1]
075	O-ring	NBR	13.2x2.62	OR 117	1
076	O-ring	NBR	7.59x2.62	OR 3030	1
090	Cover box gasket	NBR			[1]
092	Lip seal	0.65-0.9 kW	-	17x32x6	1
		1.5-2.2 kW	-	20x30x4	1
		2.2M-3 kW	-	25x40x7	1
093	Lip seal	0.65-0.9 kW	-	15x30x5	1
		1.5-2.2 kW	-	17x32x7	1
		2.2M-3 kW	-	25x40x7	1
111	Mechanical seal	Ceramic/Carbon/NBR	see pag. 303		1
115	O-ring	NBR	139.3x3.53	OR 4550	2
117	Flange gasket	EPDM			2
120	Tie rod	Fe 42 Galvanized			4
120-1	Screw for counterflange	Galvanized steel			4
128	Nut for tie rod	Galvanized steel	M12	UNI 5588	4
135	Washer	Galvanized steel	13x24x2.5	UNI 6592	4
137	Shaft washer	EN 1.4301 (AISI 304)			1
212	Screw for fan cover	Galvanized steel			4
219	Counter flange	Galvanized steel			2

Counterflange kit on request

[1] See CONSTRUCTION 3

[2] Only for single phase

(3/3)

Construction

Pump name

Customer	Date	2024-06-16	Company
Contact	Item no.		Issued by
Phone	Project		Phone
E-mail	Project ID	Proiect redenumit 2024-06-16 15:45:44	E-mail

QUANTITY FOR MODEL

Model	005-1	005-2	007	017	043	043-1	043-2	044	052	053	058	059	090
HVH 3-3N/0.65 M	1	-	3	-	4	-	-	-	1	1	1	1	1
HVH 3-3N/0.65	1	-		1	4	-	-	-	-	-	-	-	-
HVH 3-4N/0.65 M	2	-	4	-	6	-	-	-	1	1	1	1	1
HVH 3-4N/0.65	2	-		1	6	-	-	-	-	-	-	-	-
HVH 3-5N/0.9 M	3	-	5	-	8	-	-	-	1	1	1	1	1
HVH 3-5N/0.9	3	-		1	8	-	-	-	-	-	-	-	-
HVH 3-6N/0.9 M	4	-	6	-	10	-	-	-	1	1	1	1	1
HVH 3-6N/0.9	4	-		1	10	-	-	-	-	-	-	-	-
HVH 3-7N/1.5 M	4	1	7	-	10	1	1	1	1	1	1	1	1
HVH 3-7N/1.5	4	1		1	10	1	1	1	-	-	-	-	-
HVH 3-8N/1.5 M	5	1	8	-	12	1	1	1	1	1	1	1	1
HVH 3-8N/1.5	5	1		1	12	1	1	1	-	-	-	-	-
HVH 3-9N/1.5 M	6	1	9	-	14	1	1	1	1	1	1	1	1
HVH 3-9N/1.5	6	1		1	14	1	1	1	-	-	-	-	-
HVH 5-3N/0.65 M	1	-	3	-	4	-	-	-	1	1	1	1	1
HVH 5-3N/0.65	1	-		1	4	-	-	-	-	-	-	-	-
HVH 5-4N/0.9 M	2	-	4	-	6	-	-	-	1	1	1	1	1
HVH 5-4N/0.9	2	-		1	6	-	-	-	-	-	-	-	-
HVH 5-5N/1.5 M	3	-	5	-	8	-	-	-	1	1	1	1	1
HVH 5-5N/1.5	3	-		1	8	-	-	-	-	-	-	-	-
HVH 5-6N/1.5 M	4	-	6	-	10	-	-	-	1	1	1	1	1
HVH 5-6N/1.5	4	-		1	10	-	-	-	-	-	-	-	-
HVH 5-7N/1.5 M	4	1	7	-	10	1	1	1	1	1	1	1	1
HVH 5-7N/1.5	4	1		1	10	1	1	1	-	-	-	-	-
HVH 5-8N/2.2 M	5	1	8	-	12	1	1	1	1	1	1	1	1
HVH 5-8N/2.2	5	1		1	12	1	1	1	-	-	-	-	-
HVH 5-9N/2.2 M	6	1	9	-	14	1	1	1	1	1	1	1	1
HVH 5-9N/2.2	6	1		1	14	1	1	1	-	-	-	-	-
HVH 10-3N/1.5 M	1	-	3	-	4	-	-	-	1	1	1	1	1
HVH 10-3N/1.5	1	-		1	4	-	-	-	-	-	-	-	-
HVH 10-4N/1.5 M	2	-	4	-	6	-	-	-	1	1	1	1	1
HVH 10-4N/1.5	2	-		1	6	-	-	-	-	-	-	-	-
HVH 10-5N/2.2 M	3	-	5	-	8	-	-	-	1	1	1	1	1
HVH 10-5N/2.2	3	-		1	8	-	-	-	-	-	-	-	-
HVH 10-6N/2.2 M	3	1	6	-	8	1	1	1	1	1	1	1	1
HVH 10-6N/2.2	3	1		1	8	1	1	1	-	-	-	-	-
HVH 10-7N/3	4	1	7	1	10	1	1	1	-	-	-	-	-
HVH 10-8N/3	5	1	8	1	12	1	1	1	-	-	-	-	-