

Technical Data

Pump Name

IDROGO 40/15

Customer	Date	2024-06-16	Company
Contact	Item no.		Issued by
Phone	Project		Phone
E-mail	Project ID	Proiect redenumit 2024-06-16 15:45:44	E-mail

Requested data

1	Pump type		SUBMERSIBLE MULTISTAGE PUMPS	Fluid		Water
2	Number of pumps / Reserve		1 / 0	Liquid temperature	°C	20
3	Flow	m³/h		Kin. viscosity	mm²/s	1.005
4	Head	m		Vapour pressure	bar	0.0234
5	Geodetic head	m		PH value		
6	Inlet pressure (pin)	bar	0	Density	kg/m³	998.3
7	Available system NPSH			Solids	Weight %	0
8	Ambient temperature	°C	20			

Pump

9	Pump Name		IDROGO 40/15	Frequency	Hz	50
10	Design		SUBMERSIBLE MULTISTAGE PUMPS	Installation type		Without switch (STANDARD)
11	Manufacturer		EBARA	Impeller Diameter	Max. mm	104
12	Speed	rpm	2800		Designed mm	104
13	No. of Stage		7		Min. mm	104
14	Connection	Suction side	Strainer	Flow	Operating m³/h	
15	Connection	Discharge side	UNI ISO 228		Max- m³/h	4.8
16	Max Working Pressure	bar	10		Min- m³/h	1.2
17	Shut-off head	bar	8.23	Head	Operating m	
18	Total weight	kg	See the table of "Dimensions".		- (Qmax.) m	23.5
19	Shaft power	kW			- (Qmin.) m	75.7
20				Max. Shaft Power at max. impeller	kW	
21	Required pump NPSH	m		Efficiency	%	

Materials

22	Impeller		PPE+PS glass fiber reinforced			
23	Casing		AISI 304			
24	Shaft		AISI 431			
25						
26						
27						

Motor

28	Manufacturer		EPE Standard	Insulation class		F
29	Type		IDROGO M 40/15_230_Single Phase	Phases		1~
30	Specific design		Submersible dry type / 50 Hz / Pole pairs 1	Frame size		
31	Rated power	kW	1.1	Weight	kg	
32	Number of poles		2	Electric voltage	V	230
33	Speed	rpm	2800	Electric current	A	7.3
34	Degree of protection		IP 68			
35						

Remarks

Performance Curve

Pump Name

IDROGO 40/15

Customer	Date	2024-06-16	Company
Contact	Item no.		Issued by
Phone	Project		Phone
E-mail	Project ID	Proiect redenumit 2024-06-16 15:45:44	E-mail

Requested data

1	Flow	m³/h	
2	Head	m	
3	Geodetic head	m	

Pump

Operating flow	m³/h		Frequency	Hz	50
Operating head	m		Number of poles		2
Impeller diameter designed	mm	104	Speed	rpm	2800

Test standard: ISO 9906:2012 - Grade3B

Water; 20°C; 998.3kg/m³; 1mm²/s

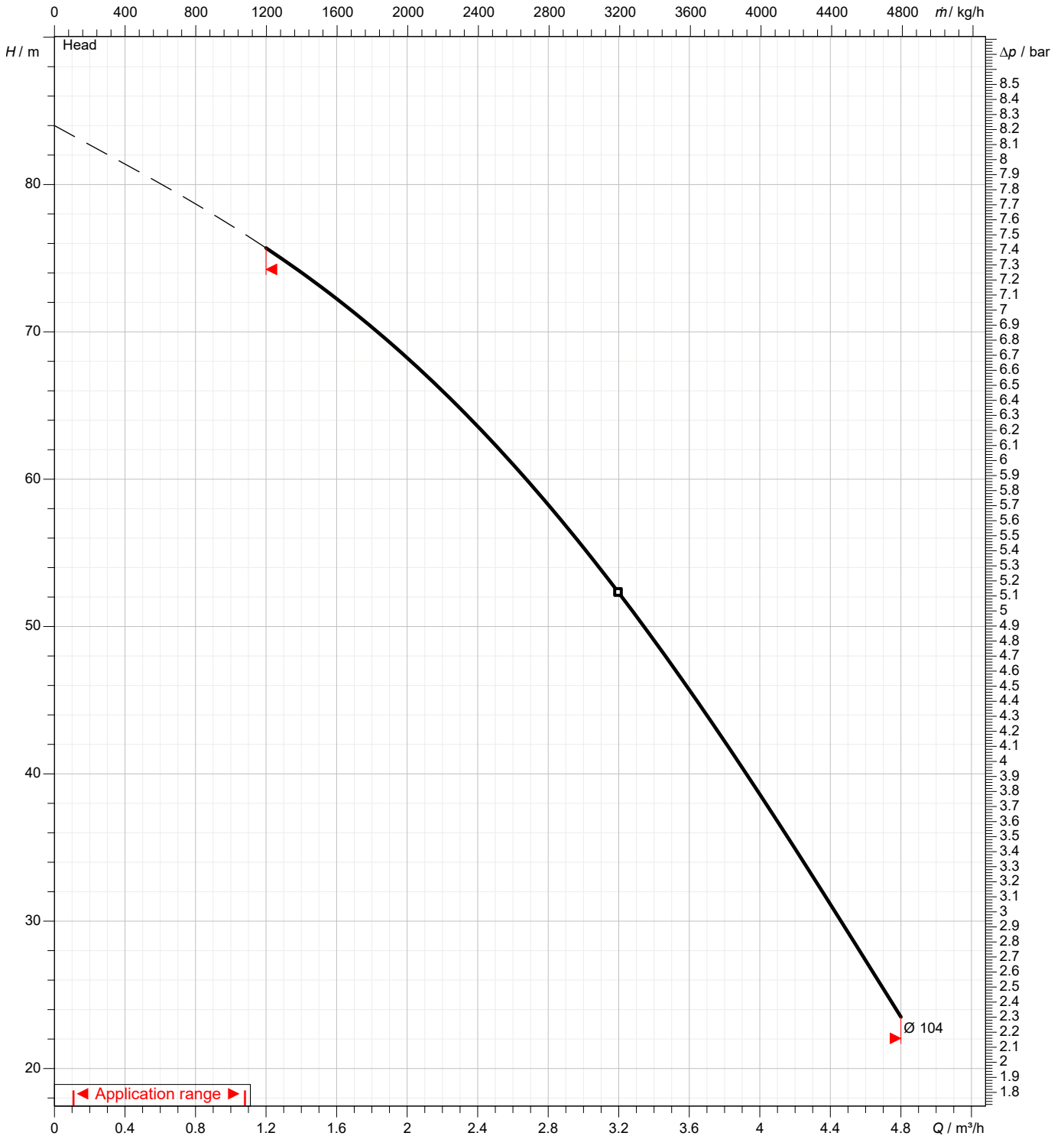

Dimensions

Pump name IDROGO 40/15

Customer	Date 2024-06-16	Company
Contact	Item no.	Issued by
Phone	Project	Phone
E-mail	Project ID Proiect redenumit 2024-06-16 15:45:44	E-mail

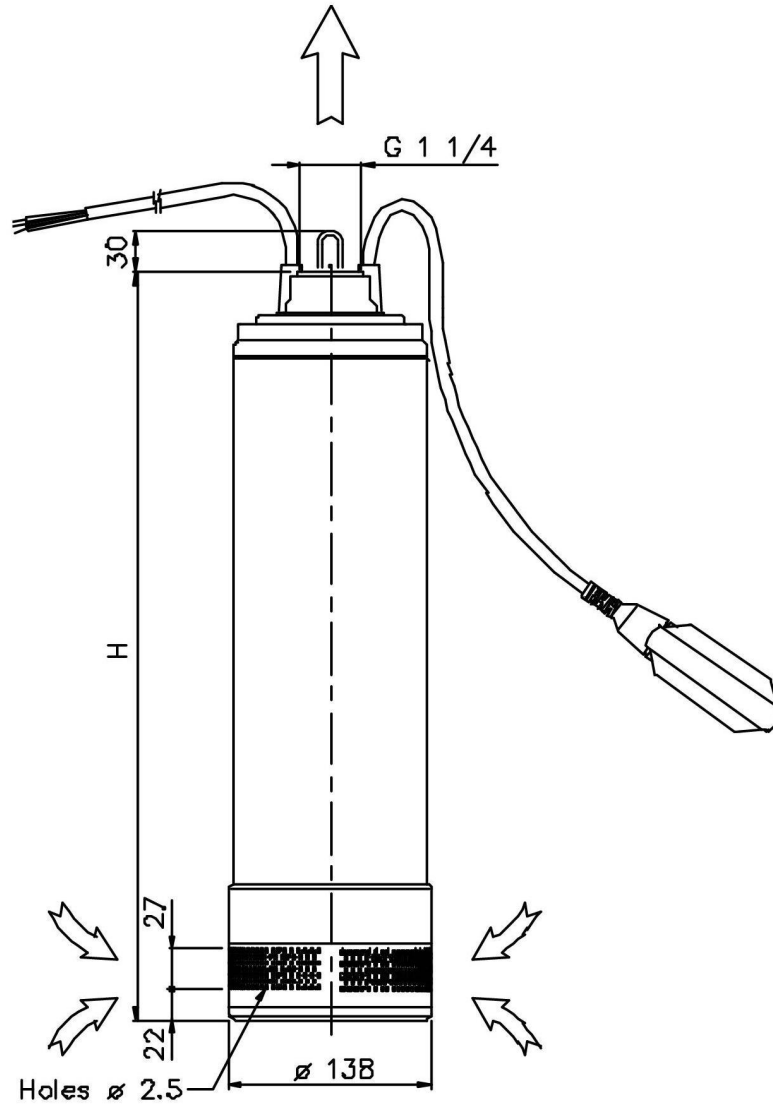

Dimensions in		mm					
1	H	616					
2	Weight PUMP	18 kg					
3							
4							
5							
6							
7							
8							
9							
10							
11							
12							
13							
14							
15							

(1/4)

Construction

Pump name IDROGO 40/15

Customer	Date 2024-06-16	Company
Contact	Item no.	Issued by
Phone	Project	Phone
E-mail	Project ID Proiect redenumit 2024-06-16 15:45:44	E-mail

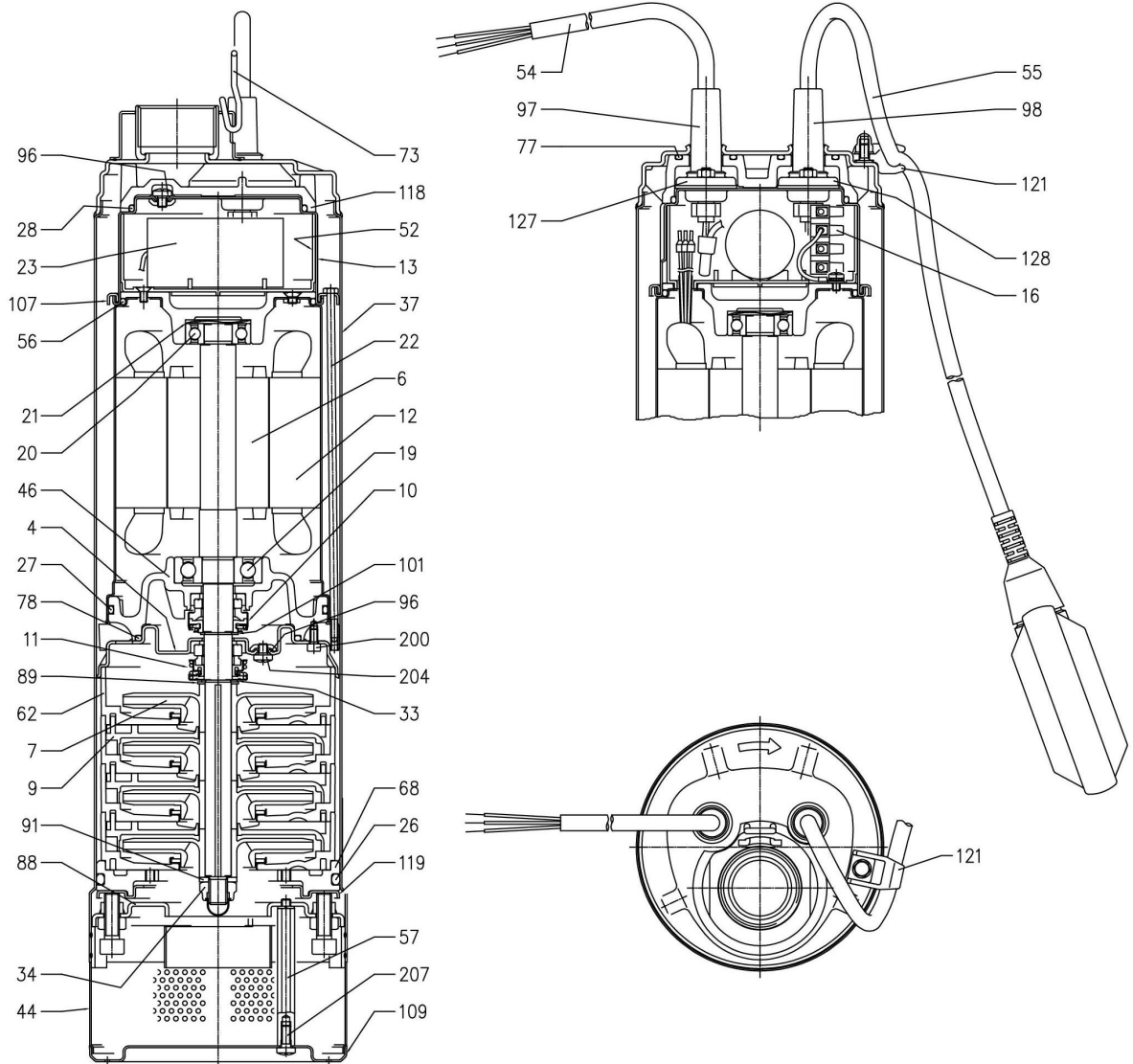

(2/4)**Construction****Pump name IDROGO 40/15**

Customer	Date	2024-06-16	Company
Contact	Item no.		Issued by
Phone	Project		Phone
E-mail	Project ID	Proiect redenumit 2024-06-16 15:45:44	E-mail

N°	PART NAME	MATERIAL	DIMENSIONS	STANDARD	Q.TY
4	Casing cover	EN 1.4301 (AISI 304)			1
6	Shaft with rotor	EN 1.4057 (AISI 431)			1
7	Impeller	PPE+PS glass fiber reinforced			[4]
9	Diffuser	PPE+PS glass fiber reinforced			[4]
10	Motor side mechanical seal [3]	Carbon/Ceramic/NBR			1
11	Pump side mechanical seal [3]	SiC/Carbon/NBR			1
12	Motor frame with stator	-			1
13	Motor cover	EN 1.4301 (AISI 304)			1
16	Terminal	-			1
19	Lower side ball bearing	-			1
20	Upper side ball bearing	-			1
21	Adjusting ring	Steel C70			1
22	Tie rod	EN 1.4305 (AISI 303)			3
23	Capacitor [1]	-			1
26	O ring	NBR	Ø120,7X5,34	OR 201	1
27	O ring	NBR	Ø110,7X3,53	OR 4437	1
28	O ring	NBR	Ø88,5X3,53	OR 4350	1
33	Seeger ring	EN 1.4301 (AISI 304)			1
34	Impeller nut	EN 1.4301 (AISI 304)	M10X1.5	DIN 986	1
37	External pump casing	EN 1.4301 (AISI 304)			1
44	Strainer	EN 1.4301 (AISI 304)	Ø136,5X49X0,8		1
46	Bearing housing	Brass			1
52	Terminal insulating box	PA66 glass fibre reinforced class V-0			1
54	Power cable	-			1
55	Float switch [2]	-			1
56	"O" ring	NBR	Ø98,02X3,53		1
57	Bolt	EN 1.4305 (AISI 303)			2
62	Stage housing	PPE+PS glass fiber reinforced			[4]
68	Lower spacer	PPE+PS glass fiber reinforced			1
73	Lifting holder	EN 1.4301 (AISI 304)			1
77	O ring	NBR	Ø25,8X3,53		2
78	O ring	NBR	Ø82,14X3,53		2
88	Fixing flange	EN 1.4301 (AISI 304)			1
89	Washer	EN 1.4301 (AISI 304)			1
91	Washer	EN 1.4301 (AISI 304)	Ø10,2X20X2		1
96	O ring	NBR	Ø4.48X1.78	OR 2018	3
97	Cable entry	NBR	Ø15X20		1
98	Cable entry [2]	NBR	Ø15X20		1
101	Seeger ring	EN 1.4021 (AISI 420)	Ø15	UNI 7435	1
107	Retainer ring	EN 1.4301 (AISI 304)	Ø119X1,2		1
109	Strainer cover	EN 1.4301 (AISI 304)	Ø136		1
118	Upper spacer	PPE+PS glass fiber reinforced			1
119	Flange	EN 1.4301 (AISI 304)			1
121	Support for float switch [2]	PPE+PS glass fiber reinforced			1
127	Cable connector	EN 1.4301 (AISI 304)			1
128	Cable connector	EN 1.4301 (AISI 304)			1
200	Screw	Stainless steel A2 UNI 7323	M4x8	ISO 4762	3
204	Screw	Stainless steel A2 UNI 7323	M5x6	UNI 7687	3
207	Screw	Stainless steel A2 UNI 7323	M5x12	UNI 7687	2

- [1] Only for single phase
[2] Only for single phase with float switch
[3] See CONSTRUCTION 4
[4] See CONSTRUCTION 3

(3/4)

Construction

Pump name IDROGO 40/15

Customer	Date 2024-06-16	Company
Contact	Item no.	Issued by
Phone	Project	Phone
E-mail	Project ID Proiect redenumit 2024-06-16 15:45:44	E-mail

Pump type		N°7 Impeller	N°9 Diffuser	N°62 Stage housing
Single Phase	Three Phase			
IDROGO M40/06	-	3	3	4
IDROGO M40/08	IDROGO 40/08	4	3	4
IDROGO M40/10	IDROGO 40/10	5	4	5
IDROGO M40/12	IDROGO 40/12	6	5	6
IDROGO M40/15	IDROGO 40/15	7	6	7
IDROGO M80/12	IDROGO 80/12	4	3	4
IDROGO M80/15	IDROGO 80/15	5	4	5
-	IDROGO 80/20	6	5	6

(4/4)

Construction

Pump name IDROGO 40/15

Customer	Date 2024-06-16	Company
Contact	Item no.	Issued by
Phone	Project	Phone
E-mail	Project ID Proiect redenumit 2024-06-16 15:45:44	E-mail

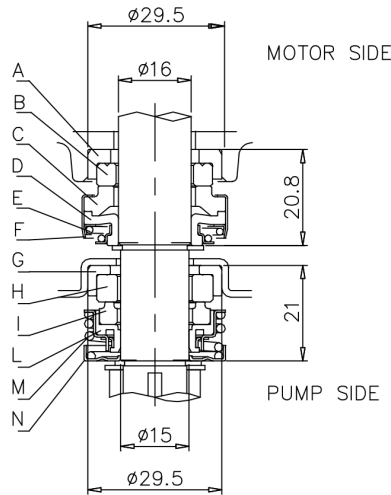

REF	PART NAME	MATERIAL Standard version (IDROGO)
A	Rubber seat	NBR
B	Stationary ring	Cearmic
C	Rotary ring	Carbon
D	Rotary seal	NBR
E	Coil spring	AISI 304
F	Seal cover	AISI 304
G	Rubber seat	NBR
H	Stationary ring	Silicon carbide
I	Rotary ring	Carbon
L	Rotary seal	NBR
M	Coil spring	AISI 304
N	Seal cover	AISI 304