

Technical data

Pump name

W6BHE32-23/45 6

Customer	Date	2024-06-20	Company
Contact	Item no.		Issued by
Phone	Project		Phone
E-mail	Project ID	Proiect redenumit 2024-06-20 16:39:09	E-mail

Requested data

1	Pump type		SUBMERSIBLE DEEPWELL PUMP	Fluid		Water
2	Number of pumps / Reserve		1 / 0	Liquid temperature	°C	20
3	Flow	m³/h		Kin. viscosity	mm²/s	1.005
4	Head	m		Vapour pressure	bar	0.0234
5	Geodetic head	m		PH value		
6	Inlet pressure (pin)	bar	0	Density	kg/m³	998.3
7	Available system NPSH			Solids	Weight %	0
8	Ambient temperature	°C	20			

Pump

9	Pump name		W6BHE32-23/45 6	Frequency	Hz	60	
10	Design		SUBMERSIBLE DEEPWELL PUMP	Installation type		STANDARD	
11	Manufacturer		EBARA	Impeller Diameter	Max.	mm	0
12	Speed	rpm	3460		Designed	mm	
13	No. of Stage		23		Min.	mm	0
14	Connection	Suction side		Flow	Operating	m³/h	
15	Connection	Discharge side			Max-	m³/h	55
16	Max Working Pressure	bar	70		Min-	m³/h	20
17	Shut-off head	bar	50.88	Head	Operating	m	
18	Total weight	kg	See the table of "Dimensions".		- (Qmax.)	m	186.9
19	Shaft power	kW	(Power / Stage)		- (Qmin.)	m	440.3
20				Max. Shaft Power at max. impeller	kW	2.10	(Power / Stage)
21	Required pump NPSH	m		Efficiency	%		

Materials

22	Impeller		EN 1.4301 (AISI 304)			
23	Discharge casing		EN 1.4301 (AISI 304)			
24	Shaft		EN 1.4057 (AISI 431)			
25	Diffuser		EN 1.4301 (AISI 304)			
26						
27						

Motor

28	Manufacturer		FRANKLIN	Insulation class		F
29	Type		BHE_6 inch_60_45_460_Three Phase	Phases		3~
30	Specific design		Submersible water filled type / 60 Hz / Pole pairs 1	Frame size		
31	Rated power	kW	45	Weight	kg	154
32	Number of poles		2	Electric voltage	V	460
33	Speed	rpm	3600	Electric current	A	91
34	Degree of protection		IP 68			
35						

Remarks

Performance curve

Pump name

W6BHE32-23/45 6

Customer	Date	2024-06-20	Company
Contact	Item no.		Issued by
Phone	Project		Phone
E-mail	Project ID	Project redenumit 2024-06-20 16:39:09	E-mail

Requested data

1	Flow	m³/h	
2	Head	m	
3	Geodetic head	m	

Pump

Operating flow	m³/h		Frequency	Hz	60
Operating head	m		Number of poles		2
Impeller Diameter	Designed	mm	Speed	rpm	3460

Test standard: ISO 9906:2012 - Grade3B

Water; 20°C; 998.3kg/m³; 1mm²/s

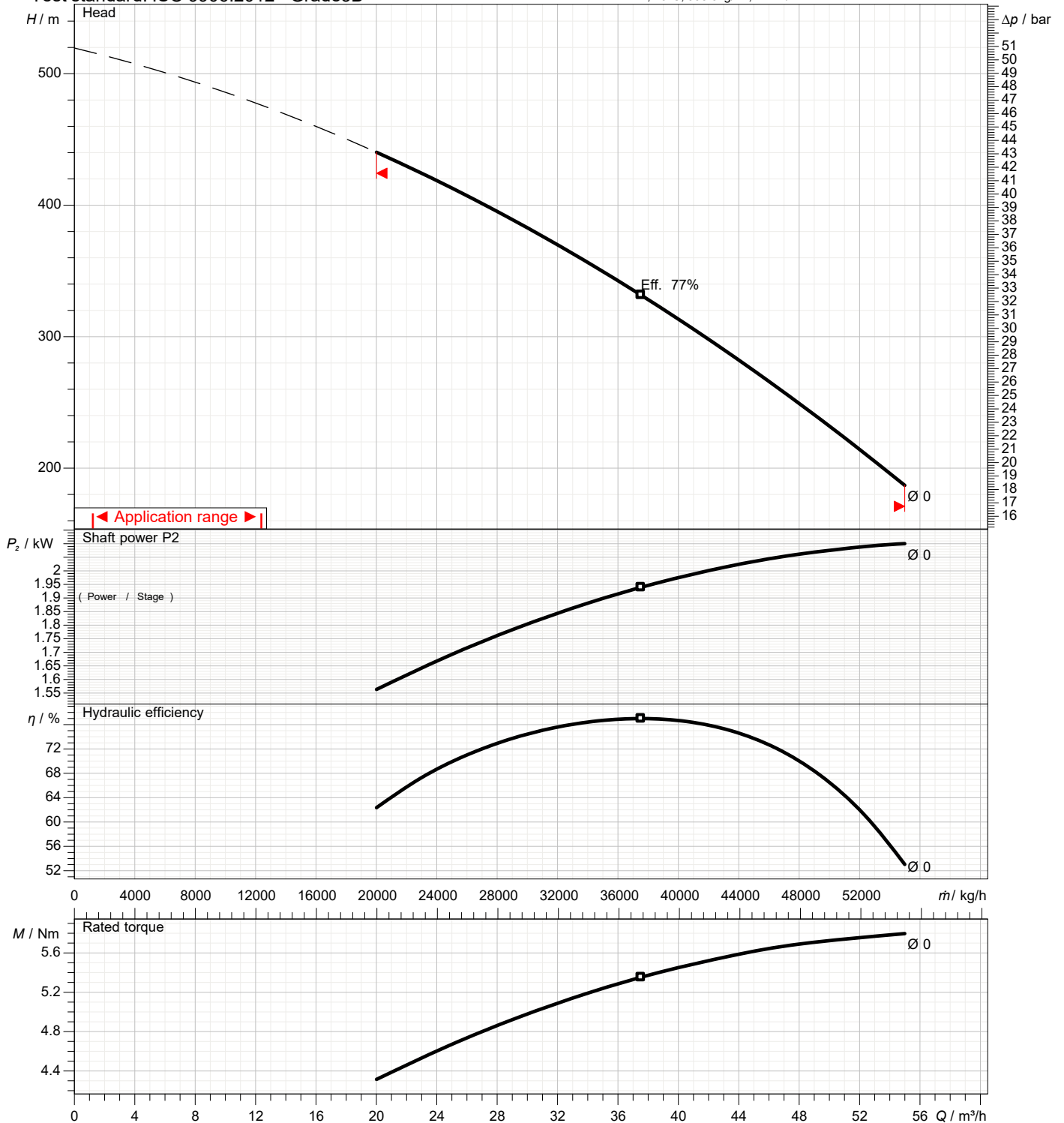

Dimensions

Pump name W6BHE32-23/45 6

Customer	Date 2024-06-20	Company
Contact	Item no.	Issued by
Phone	Project	Phone
E-mail	Project ID Proiect redenumit 2024-06-20 16:39:09	E-mail

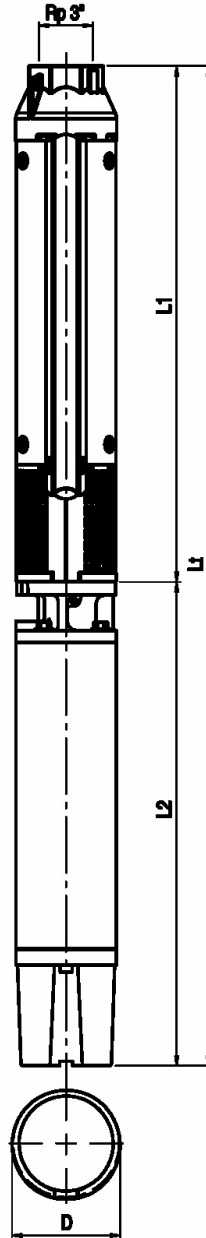

Dimensions in		mm						
1	D - 1 CABLE	143						
2	D - 2 CABLE	144.5						
3	L1	2328						
4	L2	1574						
5	Lt	3902						
6	Weight kg	362.5						
7								
8								
9								
10								
11								
12								
13								
14								
15								

(1/2) Construction

Pump name W6BHE32-23/45 6

Customer	Date 2024-06-20	Company
Contact	Item no.	Issued by
Phone	Project	Phone
E-mail	Project ID Proiect redenumit 2024-06-20 16:39:09	E-mail

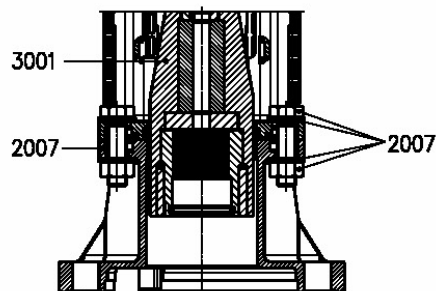
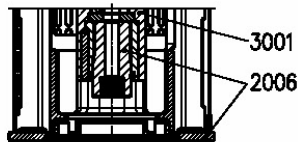
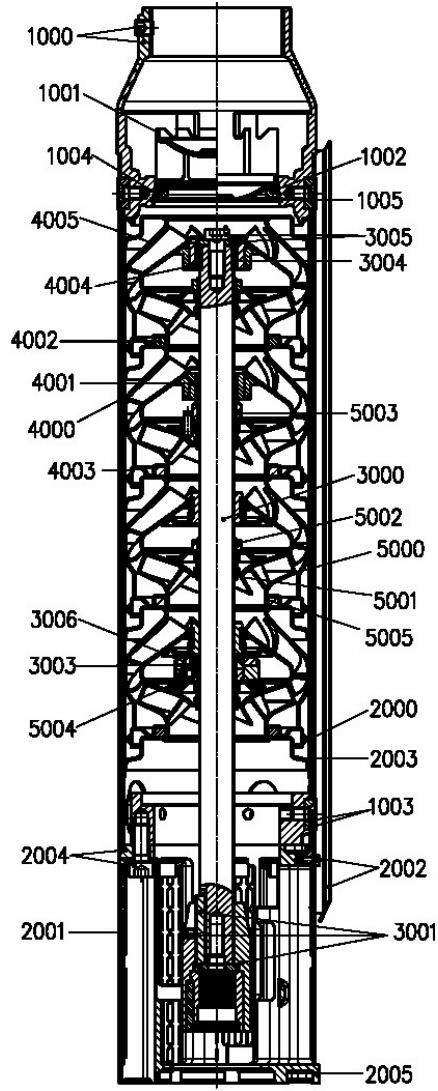

(2/2)

Construction

Pump name W6BHE32-23/45 6

Customer	Date	2024-06-20	Company
Contact	Item no.		Issued by
Phone	Project		Phone
E-mail	Project ID	Project redenumit 2024-06-20 16:39:09	E-mail

N°	PART NAME	MATERIAL	Q.TY
1000	Discharge head and screw	Stainless steel (AISI 304)	-
1001	Valve	Stainless steel (AISI 316)	-
1002	O-ring	Nitrile rubber (NBR)	--
1003	Screw s and outer case locking nuts	Stainless steel (AISI 316)	-
1004	Valve support	Stainless steel (AISI 316)	-
1005	Seeger ring	Stainless steel (AISI 316)	-
2000	Outer case	Stainless steel (AISI 304)	-
2001	Suction strainer	Stainless steel (AISI 316)	-
2002	Cable guard and screw s	Stainless steel (AISI 316)	-
2003	Initial spacer	Stainless steel (AISI 304)	-
2004	Flange and bolts	Stainless steel (AISI 304)	-
2005	Motor adapter	Stainless steel (AISI 304)	-
2006	4" motor flange/coupling adapter		-
2007	8"Motor adapter/bolts and washer	Stainless steel (AISI 431)	-
3000	Pump shaft	Stainless steel (AISI 431/329)	-
3001	Coupling	Stainless steel (AISI 316)	-
3003	Lower up-thrust washer	Stainless steel (AISI 316)	-
3004	Upper journal sleeve	Stainless steel (AISI 329) with ceramic coating	-
3005	Screw and washer	Stainless steel (AISI 316)	-
3006	Up-thrust ring	Teflon (PTFE)	-
4000	Diffusers	Stainless steel (AISI 304)	-
4001	Secondary bearing bush	Nitrile rubber (NBR)	-
4002	Floating neck ring	Teflon (PTFE)	-
4003	Flange clamping neck ring	Stainless steel (AISI 304)	-
4004	Bearing bush	Nitrile rubber (NBR)	-
4005	Last/intermediate diffuser	Stainless steel (AISI 316)	-
5000	Impeller	Stainless steel (AISI 304)	-
5001	Split cone	Stainless steel (AISI 316)	-
5002	Split cone nut	Stainless steel (AISI 316)	-
5003	Intermediate split cone nut	Stainless steel (AISI 316)	-
5004	Up-thrust split cone nut	Stainless steel (AISI 304)	-
5005	Wear ring	Stainless steel (AISI 304)	-