

Tender text

Project name
Project ID

Customer
Contact
E-mail
Phone

Company
Contact
E-mail
Phone

2025-01-20

Page 1 / 5

Pos.no	Description	Item no.
	Volute casing pump	
	Centrifugal pump: Etanorm 100-080-400/2204 GG	05120510
	Etanorm	
	Horizontal single-stage volute casing pump, ratings to EN 733, radially split volute casing with integrally cast pump feet, long-coupled design. The pump is designed with replaceable casing wear rings, closed radial impeller with multiply curved vanes, single mechanical seal or double mechanical seals to EN 12756, shaft equipped with replaceable shaft protecting sleeve in the shaft seal area. The back pull-out design allows the coupling, bearing brackets and impeller to be dismantled without the need to disconnect the pump casing from the piping.	
	Operating data	
	Fluid handled	: Water
	Flow rate	:
	Head	:
	Fluid temperature	: 20,00 °C
	Permissible fluid temperature (min./max.)	: 0 bis +110
	Maximum operating pressure	: ≤ 16 bar
	Ambient temperature (min./max.)	: -10 to +50°C
	Motor/electronics	
	MEI value	: ≥ 0,4
	Motor rating	: 22 kW
	Max. rated current	: 43,1 A
	Speed	: 500 1/min ... 1.900 1/min
	Power supply	: 3 x 380 V AC - 15 % to 480 V AC +10 %
	Motor size	: 180L
	Energy efficiency class	: IE3 = Premium Efficiency
	Enclosure	: IP55
	Motor make	: KSW - IEC
	Materials	
	Pump casing (102)	: Grey cast iron JL1040
	Impeller (230)	: Steel/tempered steel E335/C45
	Pump shaft (210)	: Grey cast iron JL1040
	Casing cover (161)	: Grey cast iron JL1040
	Casing wear ring, suction side (502.01):	DPAF seal plate, asbestos-



Tender text

Project name
Project ID

Customer
Contact
E-mail
Phone

Company
Contact
E-mail
Phone

2025-01-20

Page 2 / 5

Pos.no	Description	Item no.	Qty.	UP / EUR	TP / EUR
	free				
	Casing wear ring, discharge side (502.02): Grey cast iron GG / cast iron				
	Shaft seal type				
	: Single mechanical seal, conical casing cover				
	Shaft seal material				
	:10 = Q1Q1X4GG				
	Installation				
	Installation type				
	: Baseplate for the entire pump set (pump + drive)				
	Dimensions and connections				
	Nominal size of discharge nozzle DN2				
	: DN 080				
	Nominal diameter of suction nozzle DN1				
	: DN 100				
	Nominal pressure, suction side				
	: 16				
	Nominal pressure, discharge side				
	: 16				
	Purchase order information				
	Approx. net weight				
	: 441,7 kg				
	Make				
	: KSB				
	Type				
	: Etanorm 100-080-400/2204 GG				
	Material price group				
	: 55				
	Material number				
	: 05120510				

Data sheet: technical data

Project name
Project ID

Item-No.
Design **Volute casing pump**
Type / Coding **Etanorm 100-080-400/2204 GG**

Customer
Contact
E-mail
Phone

Company
Contact
E-mail
Phone

2025-01-20

Page 3 / 5

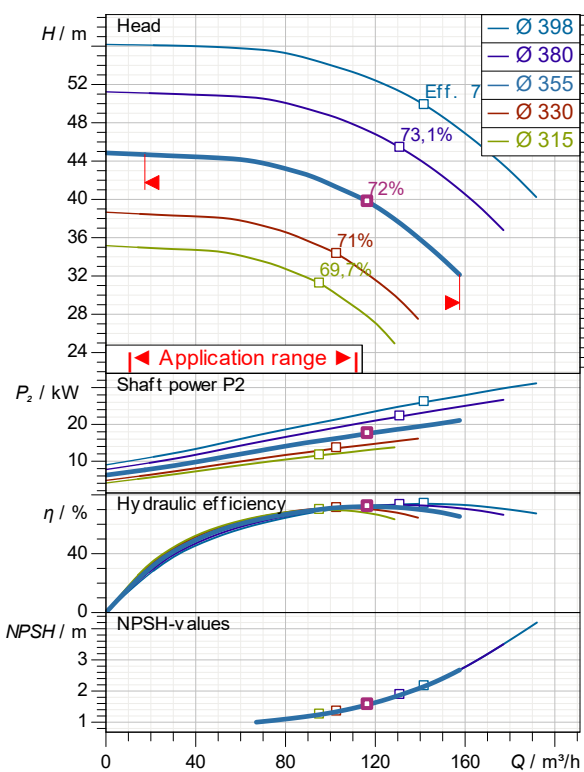

demand data

Flow
Head
Geodetic head
Media Water
Liquid temperature 20 °C
Concentration 100 %

Pump data

Make KSB
Type Etanorm 100-080-400/2204 GG
Design Volute casing pump
Specific design Single head pump
Max. fluid temperature 140 °C

Hydraulic data (Duty point)

Flow
Head
Efficiency
Minimum Efficiency Index ≥ 0,4

Material / sealing element

Volute casing Grey cast iron JL1040
Discharge cover Grey cast iron JL1040
Shaft Steel/tempered steel E335/C45
Impeller Grey cast iron JL1040
Bearing bracket lantern DPAF seal plate, asbestos-free
Casing wear ring Grey cast iron GG / cast iron

Motor data

Power uptake 23,7 kW
Rated power 22 kW
Speed 1.470 1/min
Rated voltage 400 V
Rated current 43,1 A
Degree of protection IP55

Product information

Ident. No./ type key 05120510
Weight loaded 441,7 kg
Gross price 20.180,53 EUR
PL 2025-01-20
Price group 55

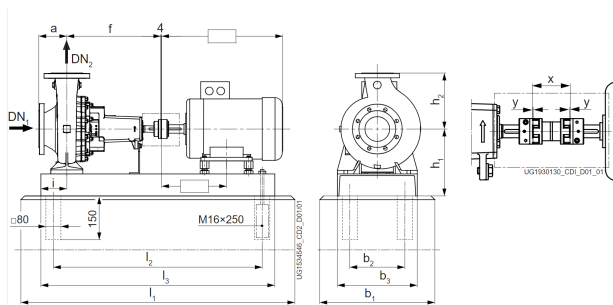

Data sheet: performance curve

Project name
Project ID

Item-No.
Design **Volute casing pump**
Type / Coding **Etanorm 100-080-400/2204 GG**

Customer
Contact
E-mail
Phone

Company
Contact
E-mail
Phone

2025-01-20

Page 4 / 5

Performance curve

Etanorm 100-080-400/2204 GG

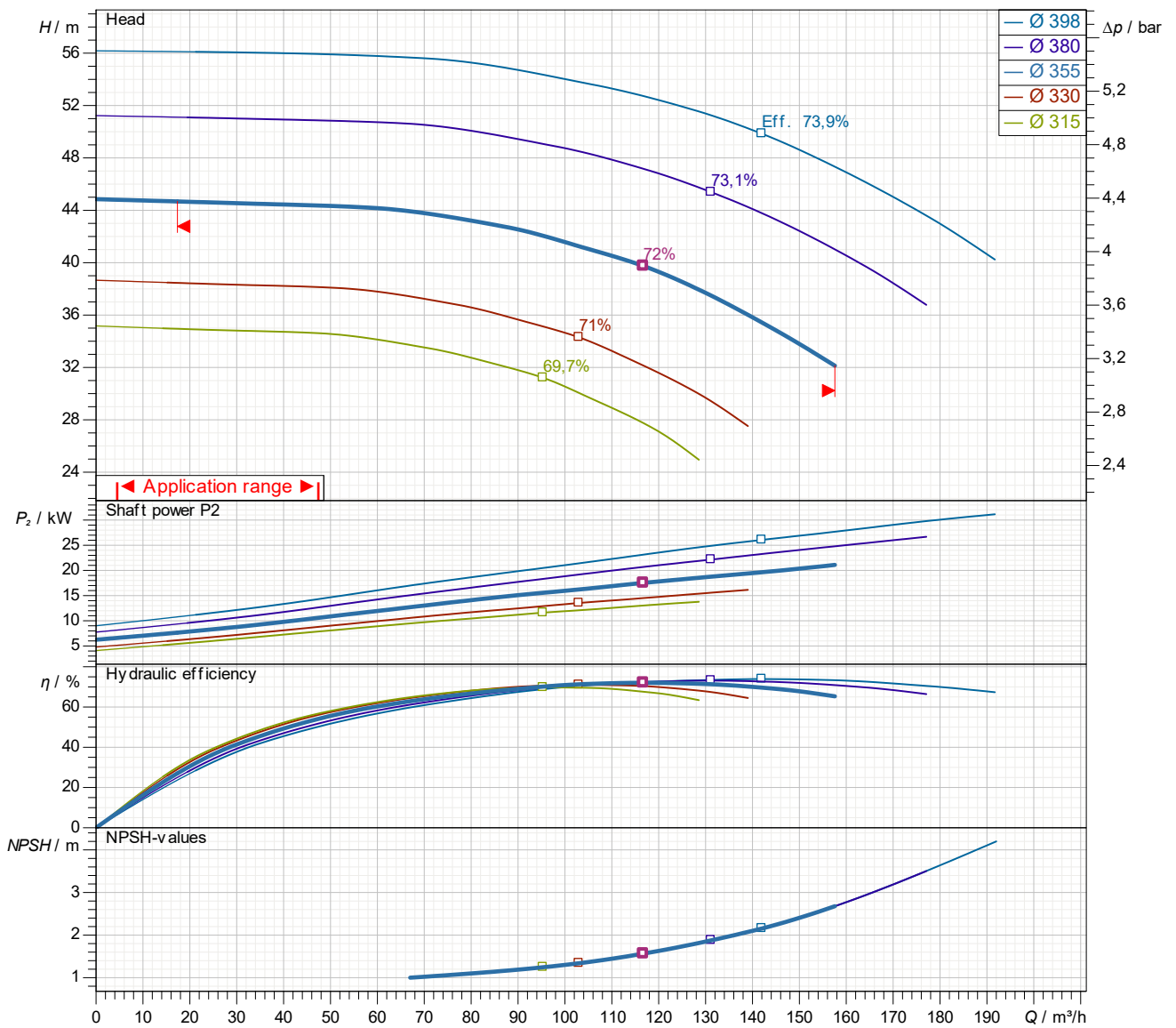

Density 998,3 kg/m³
Viscosity 1,005 mm²/s

Dimensions

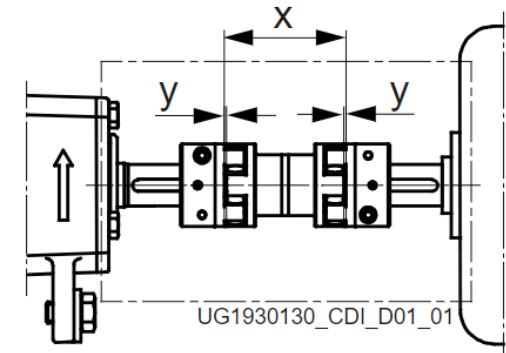
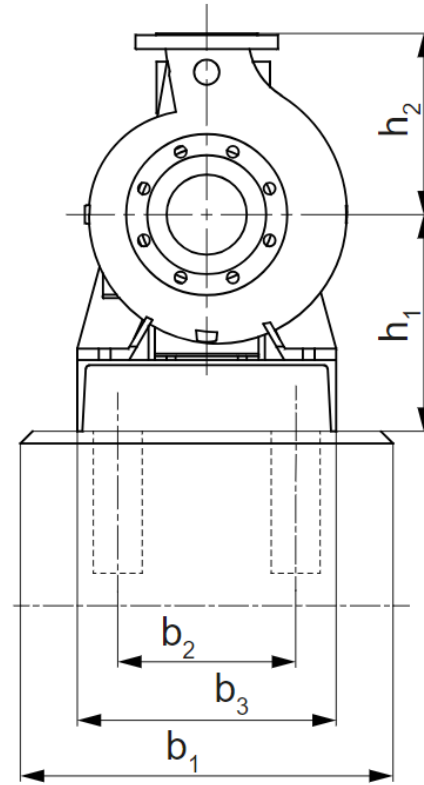
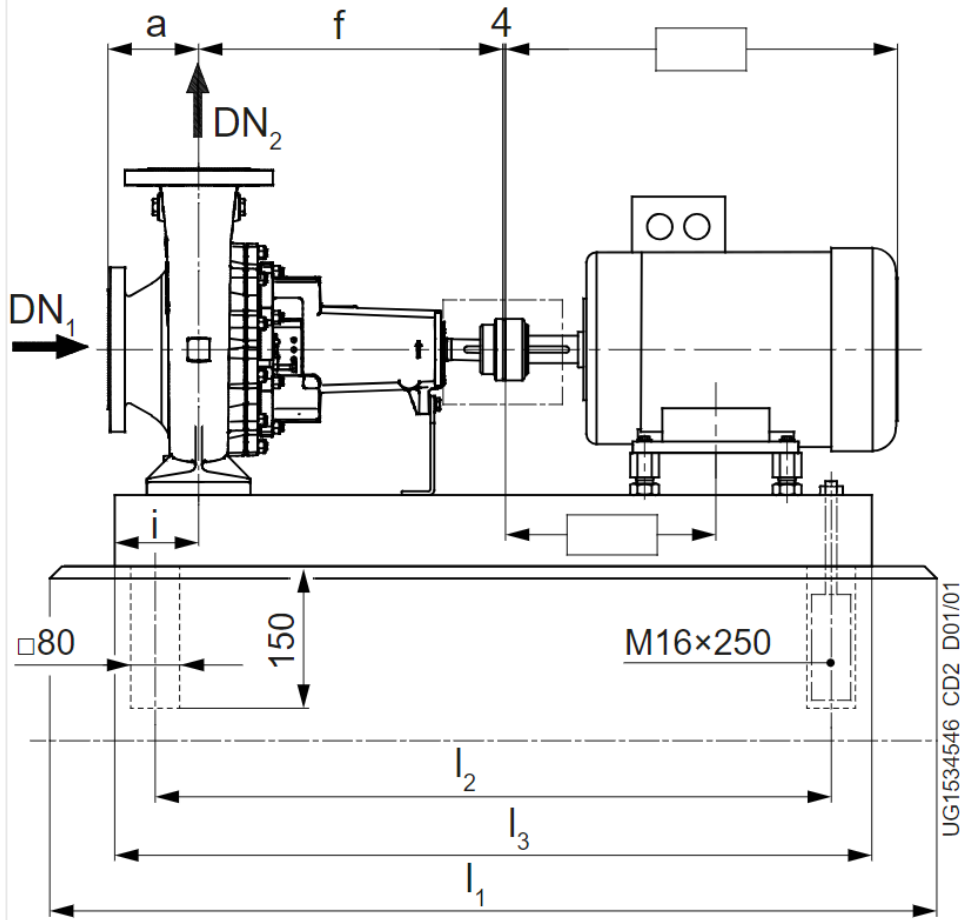

Name	Wert	Name	Wert
a	125 mm	l2	940 mm
b1	750 mm	l3	1.400 mm
b2	550 mm	x	140 mm
b3	590 mm		
DN1	100 mm		
DN2	80 mm		
f	530 mm		
h1	420 mm		
h2	355 mm		
i	112 mm		
l1	1.550 mm		