

Customer

Technical data

Single-pump system CO-1 Helix V 1003/EC

Project ID Untitled project 2025-03-03 10:19:29.207

Project name
Installation location
Customer pos. No.

Date 2025-03-03

Duty chart

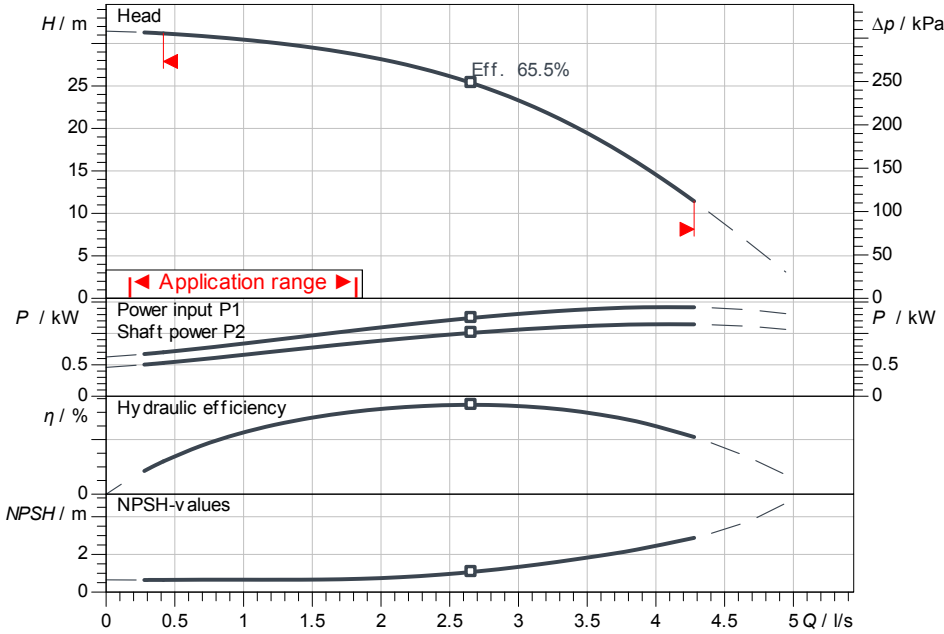

Requested data

Flow
Head
Media Water 100 %
Fluid temperature 20.00 °C
Density 998.30 kg/m³
Kin. viscosity 1.00 mm²/s

Hydraulic data (Duty point)

Flow
Head
Shaft power P2

Product data

Single-pump system
CO-1 Helix V 1003/EC
Control Without frequency conversion
No. of pumps 1
Max. operating pressure 1,600 kPa
Inlet pressure max. 1,000 kPa
Fluid temperature 3 °C ... +50 °C
Max. ambient temperature 40 °C
Protection class motor IP55
Protection class of switchgear IP54
Diaphragm pressure vessel Yes
Low-water cut-out switchgear No

Motordata per Motor/Pump

Motor efficiency level IE3
Mains connection 3~ 400 V / 50 Hz
Permitted voltage tolerance +-10 %
Rated speed 2,900 1/min
Rated power P2 1.10 kW
Rated current 2.50 A
Power factor 0.8
Efficiency 50% / 75% / 100%
Insulation class F
Motor protection Yes

Fitting dimensions

Pipe connection on the suction side Rp 1½, PN 10
Pipe connection (pressure side) G 1½, PN 16

Materials

Pump housing 1.4301
Impeller 1.4307
Shaft 1.4301
Shaft seal Q1BE3GG
Gasket material EPDM
Pipework material 1.4307

Information for order placements

Weight approx. 58 kg
Item number 2554858

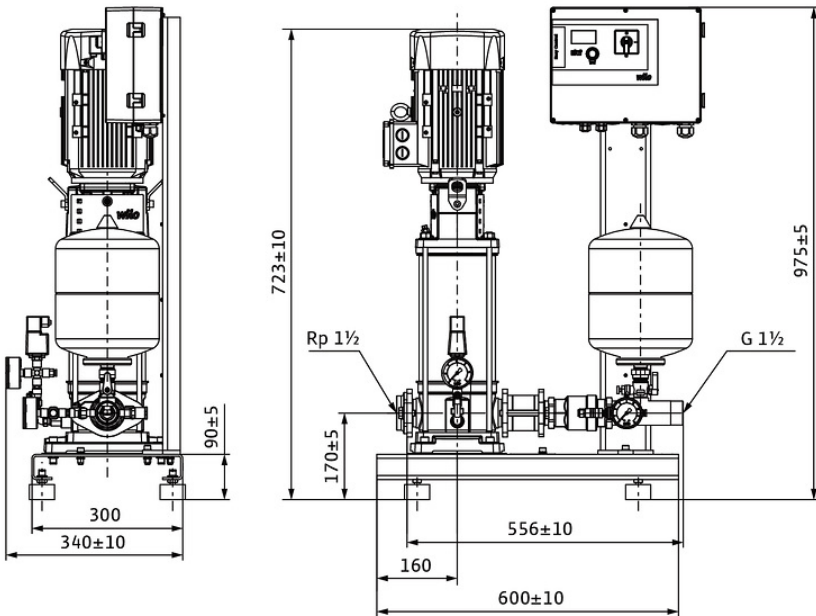

Dimensions mm

