

Customer

Technical data

High-pressure multistage centrifugal pump Zeox-FIRST V 12003-110-2

Project ID Untitled project 2025-03-04 09:37:01.987

Project name
Installation location
Customer pos. No.

Date 2025-03-04

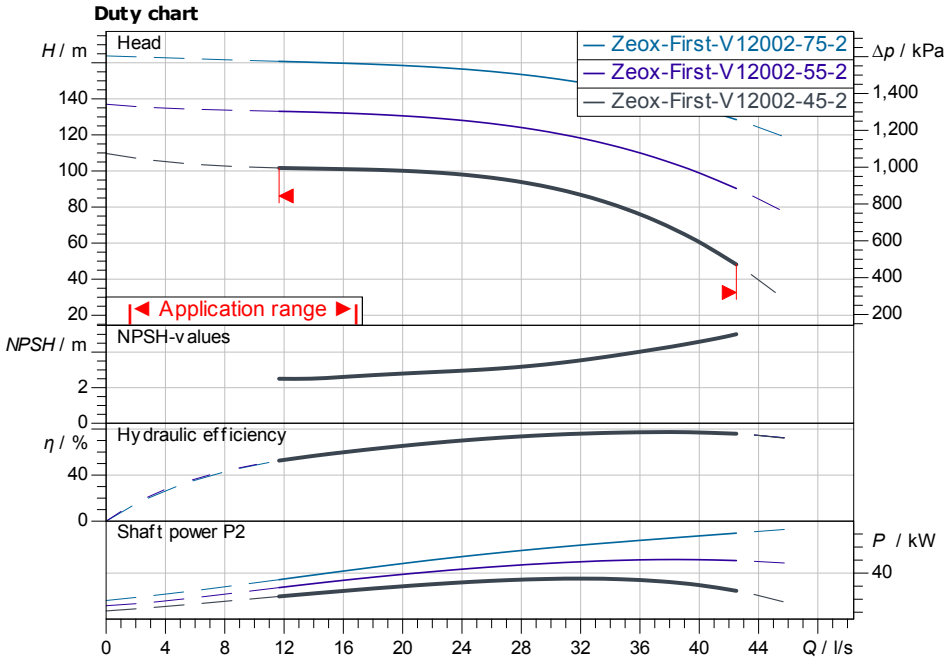

ISO 9906: 2012 3B

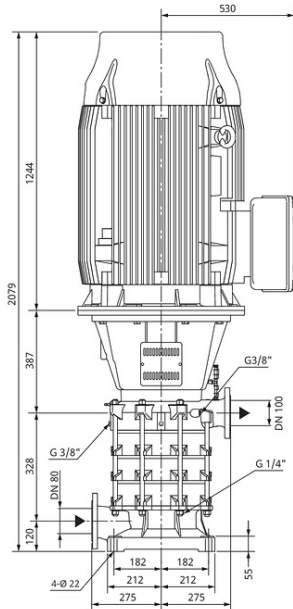

Dimensions mm

Requested data

Flow	
Head	
Media	Water 100 %
Fluid temperature	20.00 °C
Density	998.30 kg/m ³
Kin. viscosity	1.00 mm ² /s

Hydraulic data (Duty point)

Flow	
Head	
Shaft power P2	
Hydraulic efficiency	
NPSH	

Product data

High-pressure multistage centrifugal pump	
Zeox-FIRST V 12003-110-2	
Max. operating pressure	2,700 kPa
Fluid temperature	-5 °C ... +90 °C
Max. ambient temperature	40 °C
Minimum efficiency index (MEI)	

Motordata per Motor/Pump

Motor efficiency level	IE4
Mains connection	3~ 400 V / 50 Hz
Permitted voltage tolerance	+ -10 %
Max. speed	2,900 1/min
Rated power P2	110.00 kW
Rated current	189.00 A
Power factor	0.88
Efficiency	
50% / 75% / 100%	94.3/95.3/95.4%
Degree of protection	IP55
Insulation class	F
Motor protection	

Fitting dimensions

Pipe connection on the suction side	DN 100, PN 16
Pipe connection (pressure side)	DN 80, PN 40
Port to Port	

Materials

Pump housing	5.1301/EN-GJL-250
Shaft	1.6510
Shaft seal	QBPGF
Gasket material	NBR
Impeller	EN-GJL-200

Information for order placements

Weight approx.	
Item number	4191956

Contact
E-mail
Phone

Customer

Contact
E-mail
Phone

Dimensions

High-pressure multistage centrifugal pump
Zeox-FIRST V 12003-110-2

Project ID Untitled project 2025-03-04 09:37:01.987

Project name
Installation location
Customer pos. No.

Date 2025-03-04

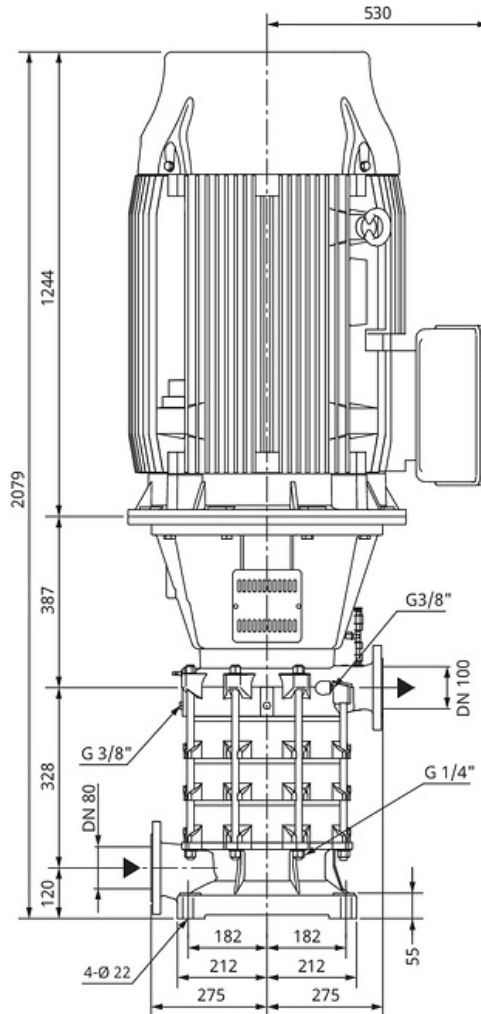

Standard

Suction side DN 100, PN 16/PN 40
Discharge side DN 80, PN 16/PN 40

Dimensions mm

Name	Value	Name	Value	Name	Value	Name	Value