

Customer

Technical data

High-pressure multistage centrifugal pump Medana CH3-LE.605-2/V/3/10T

Project ID: Untitled project 2025-03-03 23:00:00.495

Project name
Installation location
Customer pos. No.

Date: 2025-03-03

Duty chart

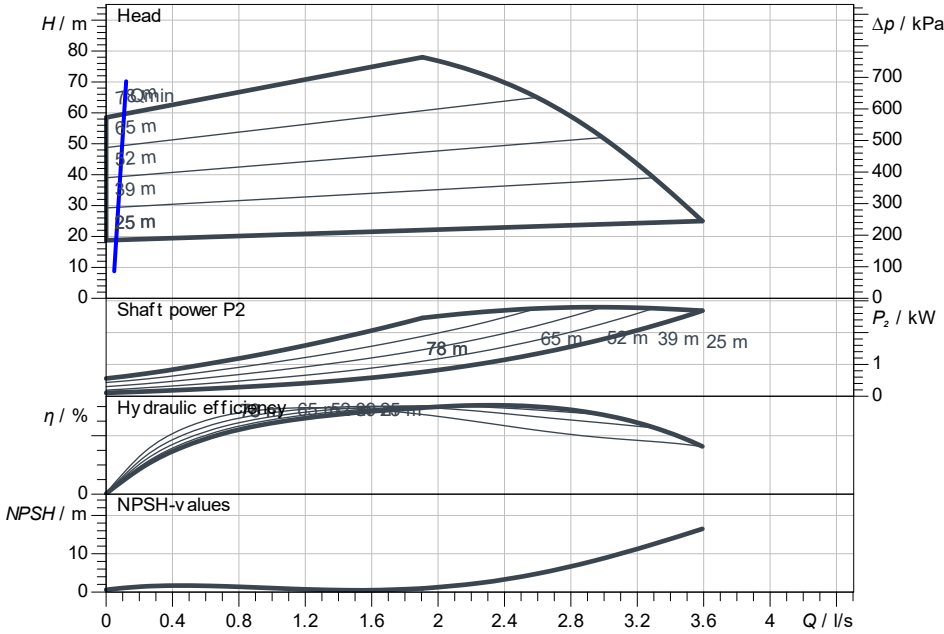

Requested data

Flow	
Head	
Media	Water 100 %
Fluid temperature	20.00 °C
Density	998.30 kg/m³
Kin. viscosity	1.00 mm²/s

Hydraulic data (Duty point)

Flow
Head

Product data

High-pressure multistage centrifugal pump Medana CH3-LE.605-2/V/3/10T	
Max. operating pressure	1,000 kPa
Inlet pressure max.	600 kPa
Fluid temperature	-20 °C ... +90 °C
Max. ambient temperature	50 °C

Motordata per Motor/Pump

Motor efficiency class	IE5
Mains connection	3~ 400 V / 50 Hz
Permitted voltage tolerance	
Max. speed	
Rated power P2	3.00 kW
Rated current	5.30 A
0	
Degree of protection	IP55
Insulation class	F
Motor protection	PTC

Fitting dimensions

Pipe connection on the suction side	Rp 1 1/4, PN 10
Pipe connection (pressure side)	Rp 1, PN 10

Materials

Pump housing	1.4404
Impeller	1.4404
Shaft	1.4404
Shaft seal	BQ1VGG
Gasket material	FKM
Stage chamber material	1.4404

Information for order placements

Weight approx.	25.8 kg
Item number	4250193

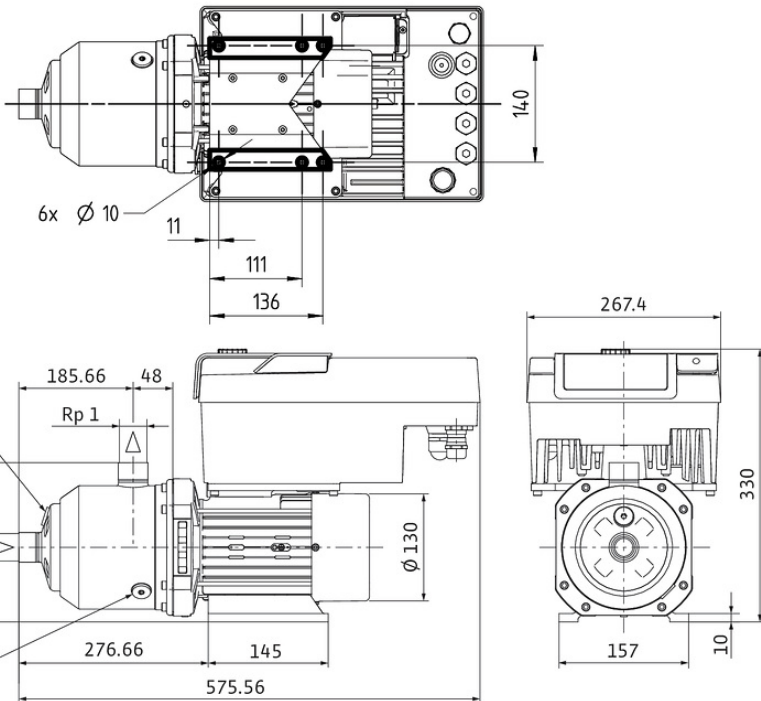

Dimensions mm