

Customer

Technical data

Multi-pump system SiBoost Smart 2 Helix VE 1009

Project ID: Untitled project 2025-03-04 01:04:54.425

Project name
Installation location
Customer pos. No.

Date: 2025-03-04

Duty chart

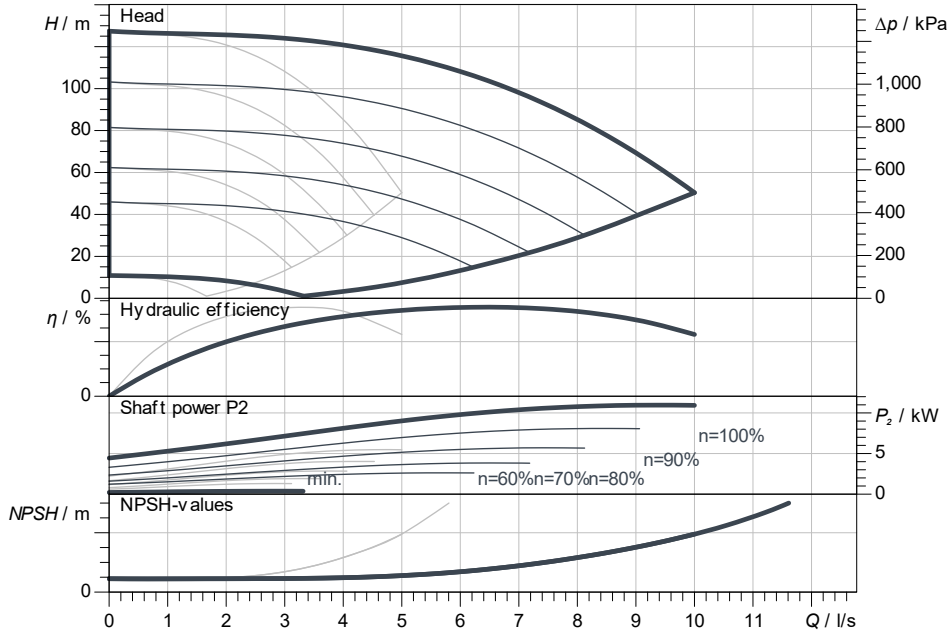

Requested data

Flow	
Head	
Media	Water 100 %
Fluid temperature	20.00 °C
Density	998.30 kg/m ³
Kin. viscosity	1.00 mm ² /s

Hydraulic data (Duty point)

Flow
Head
Shaft power P2

Product data

Multi-pump system	
SiBoost Smart 2 Helix VE 1009	
Control	With frequency converter
No. of pumps	2
Max. operating pressure	1,600 kPa
Inlet pressure max.	10 bar
Fluid temperature	3 °C ... +50 °C
Max. ambient temperature	40 °C
Protection class motor	IP 55
Protection class of switchgear	IP54
Diaphragm pressure vessel	Yes
Low-water cut-out switchgear	No

Motordata per Motor/Pump

Motor efficiency level	IE4
Mains connection	3~ 400 V / 50 Hz
Permitted voltage tolerance	±10%
Max. speed	3,500 1/min
Rated power P2	5.50 kW
Rated current	11.30 A

Efficiency	
50% / 75% / 100%	89.3/90.2/90.2%
Insulation class	F
Motor protection	Yes

Fitting dimensions

Pipe connection on the suction side	R 2½, PN 10
Pipe connection (pressure side)	R 2½, PN 16

Materials

Pump housing	1.4301
Impeller	1.4307
Shaft	1.4301
Shaft seal	Q1BE3GG
Gasket material	EPDM
Pipework material	1.4307

Information for order placements

Weight approx.	289 kg
Item number	29990298

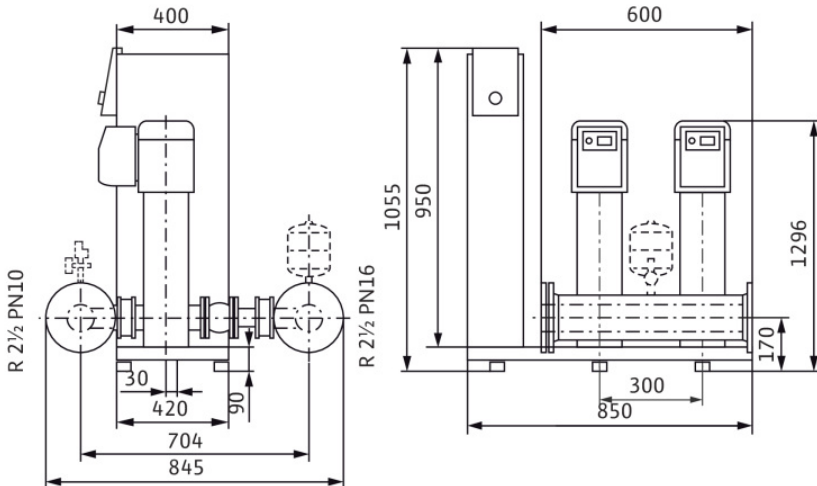

Dimensions mm

Contact
E-mail
Phone

Customer

Contact
E-mail
Phone

Dimensions

Multi-pump system

SiBoost Smart 2 Helix VE 1009

Project ID Untitled project 2025-03-04 01:04:54.425

Project name
Installation location
Customer pos. No.

Date 2025-03-04

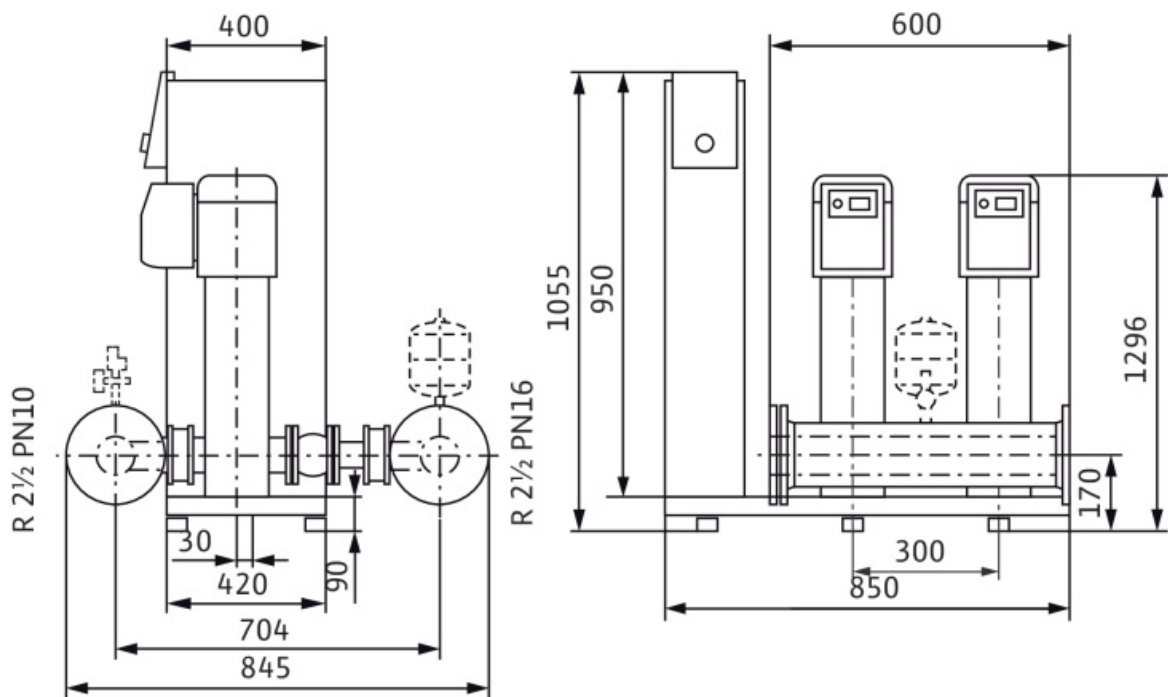

Standard

Suction side R 2 1/2, PN 10/PN 16
Discharge side R 2 1/2, PN 10/PN 16

Dimensions mm

Name	Value	Name	Value	Name	Value	Name	Value
------	-------	------	-------	------	-------	------	-------