

**Customer**

## Technical data

### Glanded energy-saving single pump Yonos GIGA2.0-I 50/1-10/1,1

Project ID: Untitled project 2025-03-04 09:37:01.987

Project name  
Installation location  
Customer pos. No.

Date: 2025-03-04

#### Duty chart

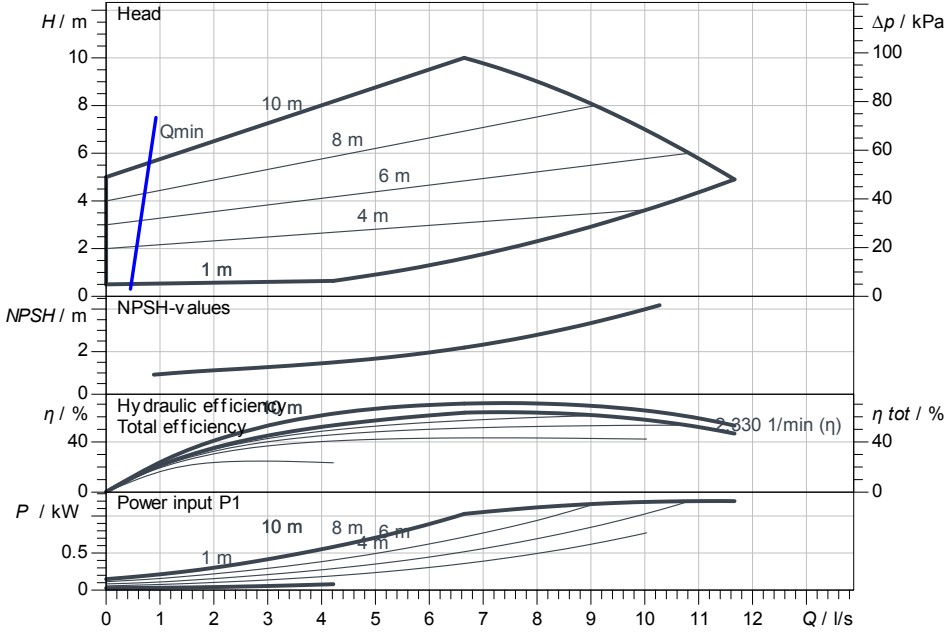

#### Requested data

Flow	
Head	
Media	Water 100 %
Fluid temperature	20.00 °C
Density	998.30 kg/m <sup>3</sup>
Kin. viscosity	1.00 mm <sup>2</sup> /s

#### Hydraulic data (Duty point)

Flow	
Head	
Power input P1	
NPSH	

#### Product data

Glanded energy-saving single pump	
Yonos GIGA2.0-I 50/1-10/1,1	
Kind of operation	dp-v
Max. operating pressure	1,600 kPa
Fluid temperature	-20 °C ... +120 °C
Max. ambient temperature	50 °C
Minimum efficiency index (MEI)	≥ 0.4

#### Motordata per Motor/Pump

Motor design	EC motor
Efficiency class	IE5
Mains connection	3~ 400 V / 50 Hz
Permitted voltage tolerance	+ -10 %
Max. speed	2,100 1/min
Rated power P2	1.10 kW
Rated current	1.90 A
Degree of protection	IP55
Insulation class	F
Motor protection	PTC integrated

#### Fitting dimensions

Pipe connection on the suction side	DN 50, PN 16
Pipe connection (pressure side)	DN 50, PN 16
Port to Port	340 mm

#### Materials

Pump housing	5.1301/EN-GJL-250
Impeller	PPE/PS-GF30
Lantern	5.1301, EN-GJL-250 cataphoretic-
Shaft	1.4021
Shaft seal	AQ1EGG

#### Information for order placements

Weight approx.	31 kg
Item number	2204985

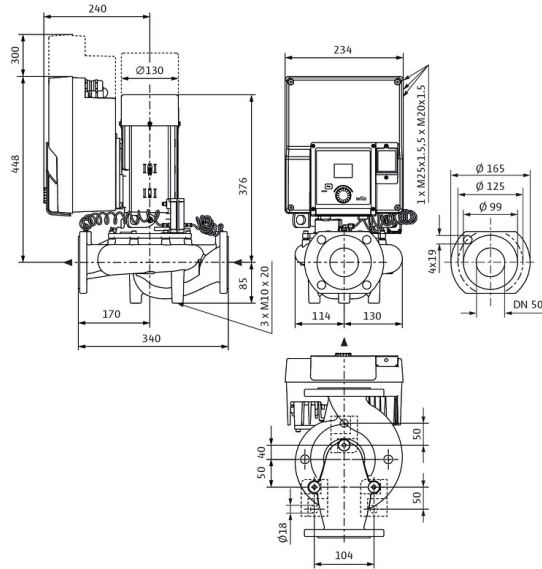

3-380V...440V, 50/60 Hz

