

Customer

Technical data

Multi-pump system SiBoost Smart 3 Helix VE 1004

Project ID: Untitled project 2025-03-04 01:04:54.425

Project name
Installation location
Customer pos. No.

Date: 2025-03-04

Duty chart

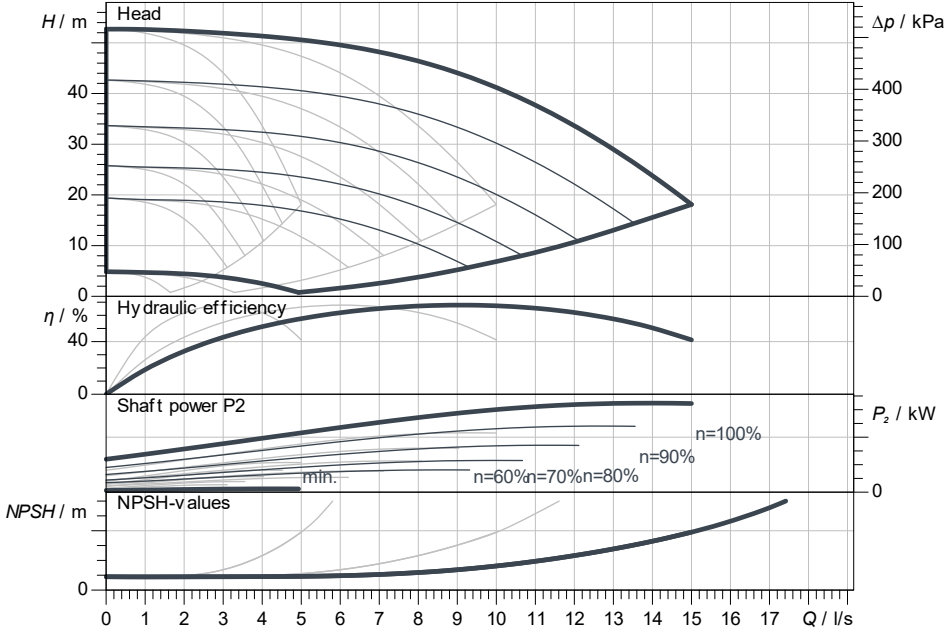

Requested data

Flow
Head
Media: Water 100 %
Fluid temperature: 20.00 °C
Density: 998.30 kg/m³
Kin. viscosity: 1.00 mm²/s

Hydraulic data (Duty point)

Flow
Head
Shaft power P2

Product data

Multi-pump system
SiBoost Smart 3 Helix VE 1004
Control: With frequency converter
No. of pumps: 3
Max. operating pressure: 1,600 kPa
Inlet pressure max.: 10 bar
Fluid temperature: 3 °C ... +50 °C
Max. ambient temperature: 40 °C
Protection class motor: IP55
Protection class of switchgear: IP54
Diaphragm pressure vessel: Yes
Low-water cut-out switchgear: No

Motordata per Motor/Pump

Motor efficiency level: IE4
Mains connection: 3~ 400 V / 50 Hz
Permitted voltage tolerance: 400/50: +/-10%, 380/6
Max. speed: 3,500 1/min
Rated power P2: 2.20 kW
Rated current: 5.10 A

Efficiency: 50% / 75% / 100% → 88.5/88.5/88.5%
Insulation class: F
Motor protection: Yes

Fitting dimensions

Pipe connection on the suction side: R 2½, PN 10
Pipe connection (pressure side): R 2½, PN 16

Materials

Pump housing: 1.4301
Impeller: 1.4307
Shaft: 1.4301
Shaft seal: Q1BE3GG
Gasket material: EPDM
Pipework material: 1.4307

Information for order placements

Weight approx.: 185 kg
Item number: 29990222

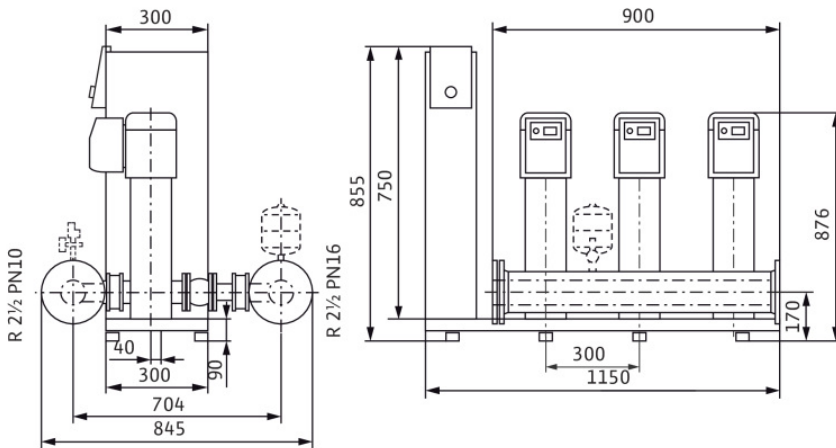

Dimensions mm

Contact
E-mail
Phone

Customer

Contact
E-mail
Phone

Dimensions

Multi-pump system

SiBoost Smart 3 Helix VE 1004

Project ID Untitled project 2025-03-04 01:04:54.425

Project name
Installation location
Customer pos. No.

Date 2025-03-04

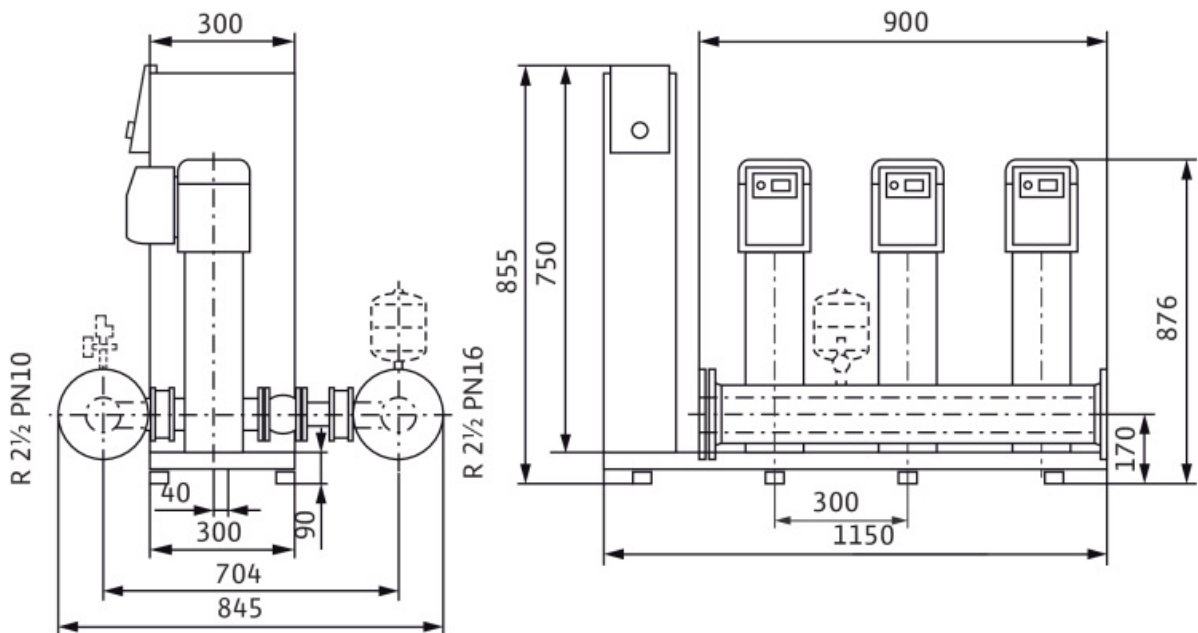

Standard

Suction side R 2 1/2, PN 10/PN 16
Discharge side R 2 1/2, PN 10/PN 16

Dimensions mm

Name	Value	Name	Value	Name	Value	Name	Value
------	-------	------	-------	------	-------	------	-------