

Customer

Technical data

Single-pump system

COR 1MHI206/EC-EM-T90

Project ID Untitled project 2025-03-02 21:16:31.415

Project name
Installation location
Customer pos. No.

Date 2025-03-02

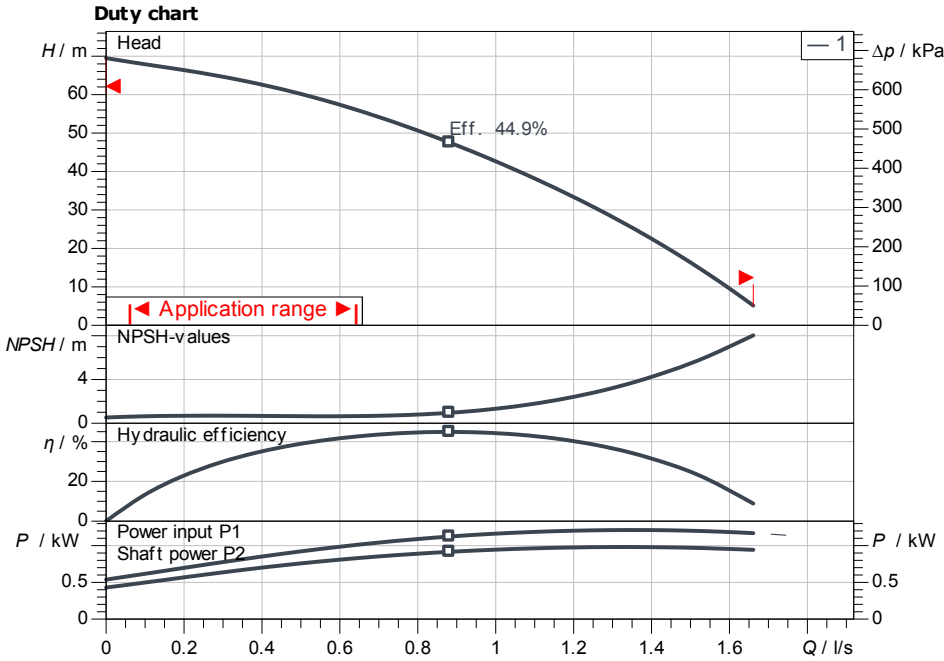

Requested data

Flow
Head
Media Water 100 %
Fluid temperature 20.00 °C
Density 998.30 kg/m³
Kin. viscosity 1.00 mm²/s

Hydraulic data (Duty point)

Flow
Head
Shaft power P2

Product data

Single-pump system
COR 1MHI206/EC-EM-T90
Control With frequency converter
No. of pumps 1
Max. operating pressure 1,000 kPa
Inlet pressure max. 6 bar
Fluid temperature 3 °C ... +50 °C
Max. ambient temperature 40 °C
Diaphragm pressure vessel Yes
Low-water cut-out switchgear Yes

Control

Mains connection 1~ 230 V
50 Hz
Protection class of switchgear IP55

Motordata per Motor/Pump

Motor efficiency level IE3
Rated power P2 1.10 kW
Rated current 2.80 A
Efficiency 50% / 75% / 100%
Protection class motor IP54
Insulation class F
Motor protection Yes

Fitting dimensions

Pipe connection on the suction side Rp ½, PN 6
Pipe connection (pressure side) Rp 1, PN 10
Overflow connection Ø 50
Gross volume 90 l

Materials

Tank PUR-GFRP
Pump housing 1.4301
Impeller 1.4301
Shaft 1.4301
Shaft seal BQ1E3GG
Gasket material EPDM
Pipework material Brass, CW617N

Information for order placements

Weight approx. 81 kg
Item number 29992986

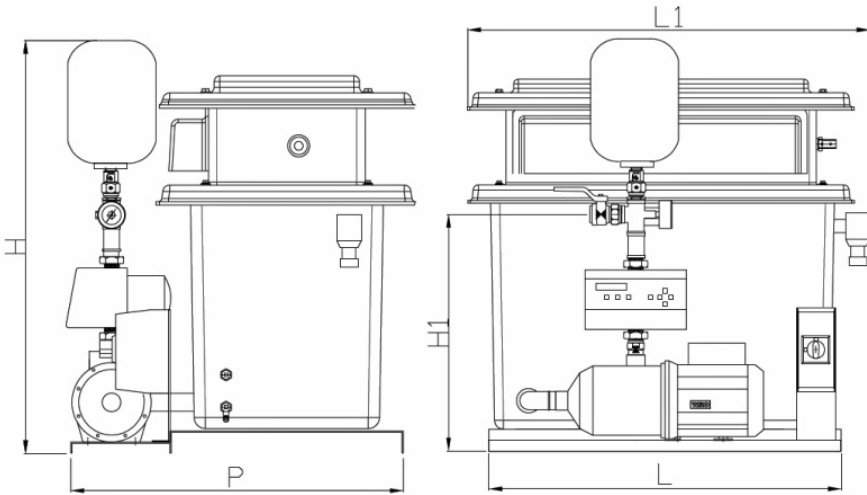

Dimensions		mm	
DNd	Rp 1, PN	L	800
DNs	Rp ½, PN	L1	870
H		LS	262
H1		P	760
HS			196

Contact
E-mail
Phone

Customer

Contact
E-mail
Phone

Dimensions

Single-pump system
COR 1MHI206/EC-EM-T90

Project ID Untitled project 2025-03-02 21:16:31.415

Project name
Installation location
Customer pos. No.

Date 2025-03-02

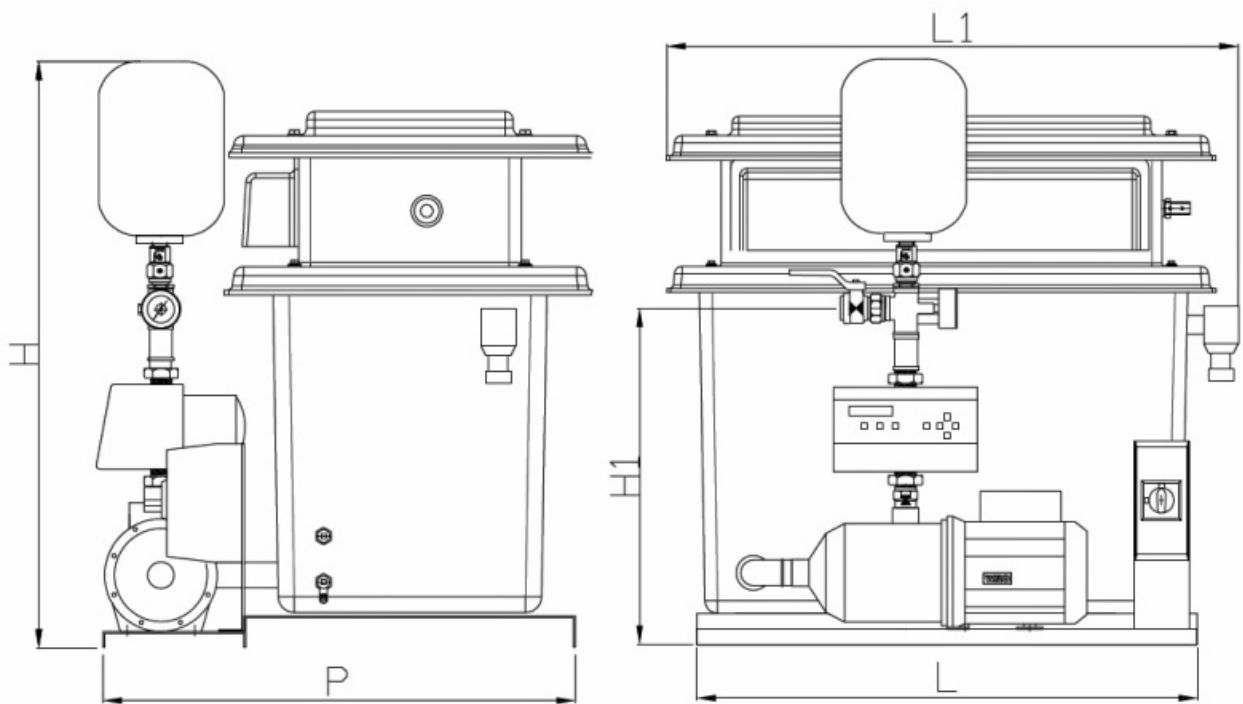

Standard

Suction side Rp 1/2, PN 6/PN 10
Discharge side Rp 1, PN 6/PN 10

Dimensions mm

Name	Value	Name	Value	Name	Value	Name	Value
DNd	Rp 1, PN 10	LS	262				
DNs	Rp 1/2, PN 6	P	760				
H	990						
H1	565						
HS	196						
L	800						
L1	870						