

ecocirc XL 40-80 F

Technical data

Company name
Contact
Phone number
e-mail address

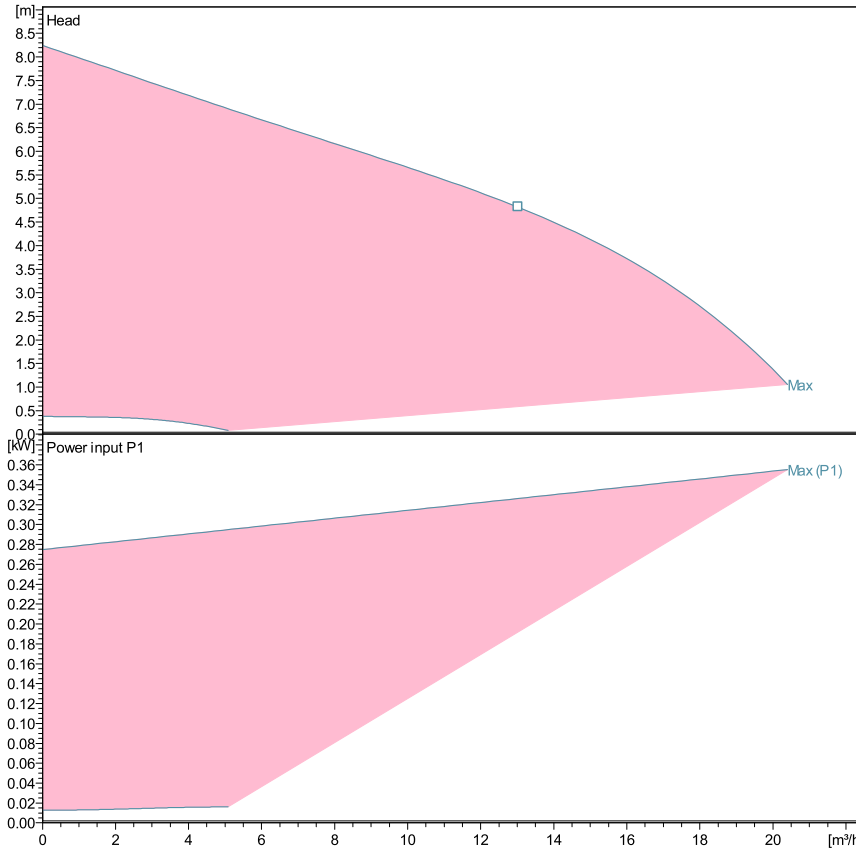

Performance according to ISO 9906:2012 – Grade 3B
Liquid temperature:
-10°C (14°F) to +110 °C (230°F) for heating pumps
-10°C (14°F) to +85 °C (185°F) for domestic hot water pumps
Power data referred to:
Water [100%]: 4°C; 1000kg/m³; 1.57mm²/s



Pump data

Make	Lowara
Port to port (mm)	220
Electrical connection	Terminals
Specific EEI	<= 0,23
Nominal pressure	PN 6/10
Connection	Flanged / DN 40

Electrical data

Rated voltage	230 V
Frequency	50 / 60
Protection class	IP 44
Insulation class	F
Digital input	Contact load: 5V, 10 mA
Digital output	Vmax < 250 VAC / Imax < 2 A
Analog input	0-10 V / 4-20 mA
Leakage current	< 3.5 mA
Communication capabilities	No communication protocol
Sound pressure level	<= 48 dB(A)
Rated current	1.4 A

Materials

Bush Bearing	Carbon, resin impregnated	Impeller	PPS
Thrust bearing	Aluminium	Wear ring	Stainless steel
Bearing plate	Stainless steel	Rotor can	Stainless steel
Motor housing	Aluminum	Shaft	Stainless steel
O-rings	EPDM	Control box	Poly carbonate
PUMP HOUSING	Cast Iron		

Dimensions mm

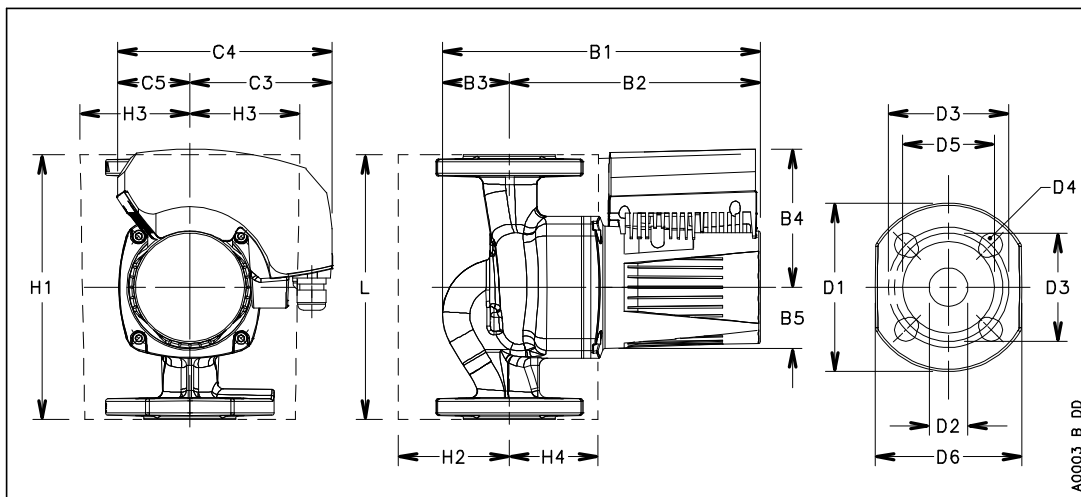

B1	322
B2	256
B3	66
B4	130
B5	51
C3	128
C4	209
C5	81
D1	150
D2	40
D3	100/100
D4	4 x 14/19
D5	84
G	DN 40
Gross Weight	17.3
H1	220
H2	94
H3	96
H4	86
L	220
Net Weight	13.8