

ecocirc XL 40-120 F

Technical data

Company name
Contact
Phone number
e-mail address

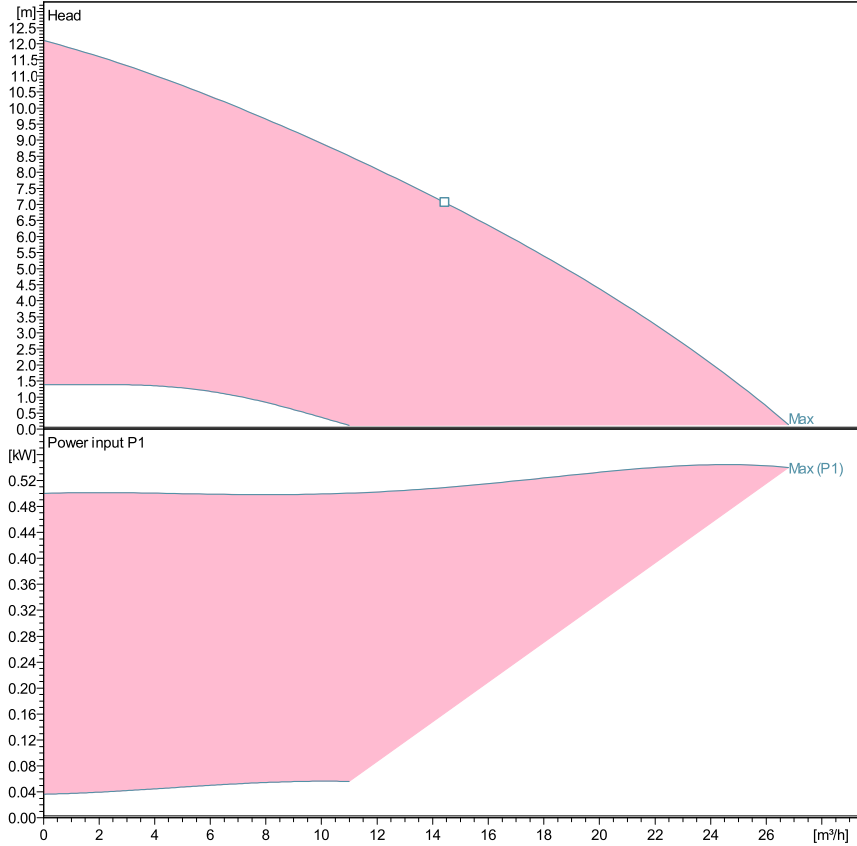

Performance according to ISO 9906:2012 – Grade 3B

Liquid temperature:

-10°C (14°F) to +110 °C (230°F) for heating pumps

-10°C (14°F) to +85 °C (185°F) for domestic hot water pumps

Power data referred to:

Water [100%]; 4°C; 1000kg/m³; 1.57mm²/s



Pump data

Make	Lowara
Port to port (mm)	250
Electrical connection	Terminals
Specific EEI	<= 0,23
Nominal pressure	PN 6/10
Connection	Flanged / DN 40

Electrical data

Rated voltage	230 V
Frequency	50 / 60
Protection class	IP 44
Insulation class	F
Digital input	Contact load: 5V, 10 mA
Digital output	Vmax < 250 VAC / Imax < 2 A
Analog input	0-10 V / 4-20 mA
Leakage current	< 3.5 mA
Communication capabilities	No communication protocol
Sound pressure level	<= 48 dB(A)
Rated current	2.4 A

Materials

Bush Bearing	Carbon, resin impregnated	Impeller	PPS
Thrust bearing	Aluminium	Wear ring	Stainless steel
Bearing plate	Stainless steel	Rotor can	Stainless steel
Motor housing	Aluminum	Shaft	Stainless steel
O-rings	EPDM	Control box	Poly carbonate
PUMP HOUSING	Cast Iron		

Dimensions mm

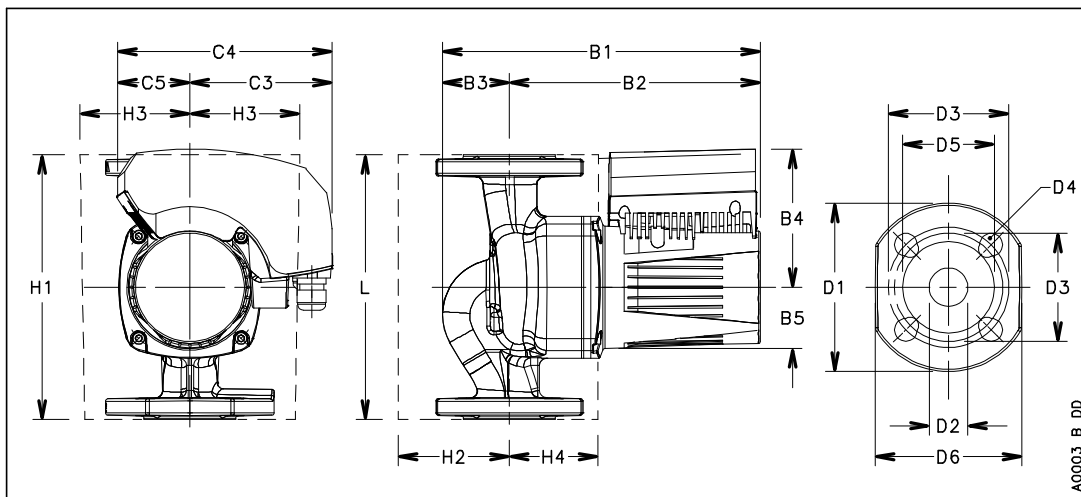

B1	338
B2	256
B3	82
B4	132
B5	53
C3	128
C4	206
C5	78
D1	150
D2	40
D3	100/110
D4	4 x 14/19
D5	84
G	DN 40
Gross Weight	17.7
H1	250
H2	87
H3	90
H4	88
L	250
Net Weight	13.9